



**INSTALLATION MANUAL**  
**MATRIX FRONT BUMPER**  
**PRODUCT NUMBER: X295X**  
**APPLICATION: 2010-2018 DODGE RAM HD**



## **IMPORTANT SAFETY GUIDE** | Your safety and the safety of others is very important.

In order to help you make informed decisions about safety, we have provided the following warnings, safety precautions, installation instructions, and other important information to alert you to potential hazards that could hurt you or others.

Please do a job safety analysis before each task to identify potential hazards for your situation and remove/protect against them. Use own good judgment and take your time.

Check packaged materials immediately upon arrival to ensure that all listed parts are included and undamaged.

**Read and understand all warnings, safety precautions, and instructions before installing this product.**

SENSORS FIELD OF VIEW MAY BE ALTERED WITH USE OF THE REPLACEMENT BUMPER.

---

### **WARNINGS**

- Failure to observe the following warnings and instructions provided in this manual could lead to severe injury and/or death.
- For professional installation only. Careless installation and/or operation can result in serious injury, death, and/or equipment damage. All liability for installation and use rests with the user or consumer.
- Fab Fours, Inc. only approves installing this product according to these written instructions with the hardware provided. Failure to install according to these instructions will invalidate the warranty. This includes, but is not limited to, using alternative installation methods, hardware, or materials.
- This product is for off road use only.

---

### **SAFETY PRECAUTIONS**

- Always remove jewelry and wear eye protection.
- Always use extreme caution when jacking up a vehicle for work. Set emergency brake and use tire blocks. Locate and use the vehicle manufacturers designated lifting points. Use jack stands.
- Always use appropriate and adequate care in lifting components into place.
- Always ensure components will remain secure during installation and operation.
- Always wear safety glasses when installing this kit. A drilling operation will cause flying metal chips. Flying chips can cause serious eye injury.
- Always use extreme caution when drilling a vehicle. Always disconnect power before welding. Thoroughly inspect the area to be drilled (on both sides of material when possible) prior to drilling, and relocate any objects that may be damaged.
- Always use extreme caution when welding a vehicle. Thoroughly inspect the area to be welded (on both sides of material when possible) prior to welding, and relocate any objects that may be a fire hazard. When welding in a cab, make sure the interior surfaces are covered (e.g., welding blanket) and a fire extinguisher is at hand.
- Always use extreme caution when cutting and trimming during fitting.
- Always tighten all nuts and bolts securely per installation instructions.
- Always route electrical cables carefully. Avoid moving parts, components that become hot, and rough or sharp edges.
- Always insulate and protect all exposed wiring and electrical terminals.
- Perform regular inspections and maintenance on mounts and hardware.

# TABLE OF CONTENTS

- 2 SAFETY / DISCLAIMER
- 3 TABLE OF CONTENTS
- 4 A MESSAGE FROM THE OWNER
- 5 GETTING STARTED
- 6 PROVIDED MATERIAL
- 8 DISASSEMBLY
- 12 INSTALLATION
- 15 CONTACT

# A MESSAGE FROM THE OWNER

---



Fab Fours' was born out of a passion for customizing vehicles and a love of the outdoors. Our engineering team uses the latest 3D design software to turn new product ideas into reality. In our factory, designs come to life with the combination of cutting edge technology for metal cutting and forming and an American workforce that puts its' heart and pride into every product.

From design and manufacturing, to quality and delivery, Fab Fours' mission is to be the market leader for steel truck and jeep accessories. We make sure a quality product is delivered on time, more than expected, better than expected to our customers.

Enjoy your new Fab Fours product. Welcome to the family!

*Ereg Higgs*

**FOUNDER, FAB FOURS**

# GETTING STARTED

---

Before you begin the installation process of your new Fab Fours product, we suggest laying out all materials and parts on a pad or protective surface.

Failure to fully account for all components before beginning installation may leave vehicle immobile until part is acquired. Refer to the next pages as an inventory check.



# PROVIDED MATERIALS

---

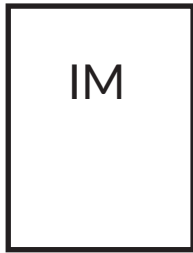

X295X-IM



50183-HW

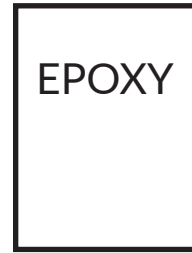

61632  
QTY: 2

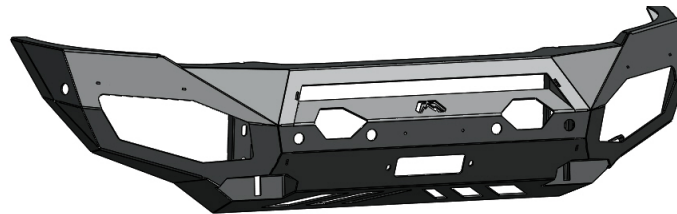

21898

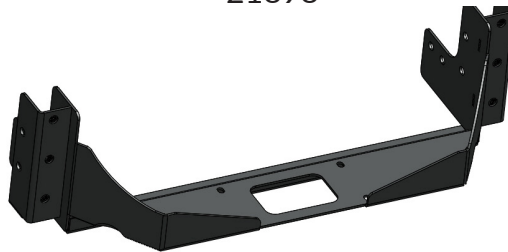

21899

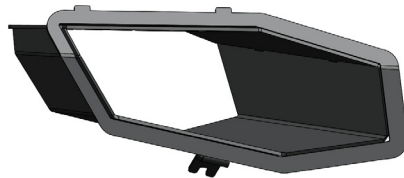

21901

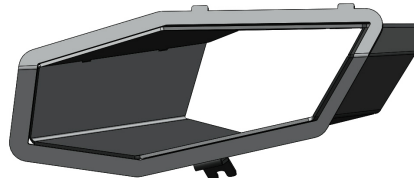

21900

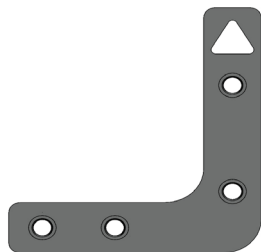

21922-02

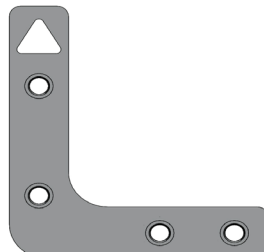

21922-01



21871  
QTY: 2

## HARDWARE KIT | 50183

FAB FOURS IDENTIFICATION	COMPONENT DESCRIPTION	QTY
50183-HW	1/4"-20 x 1", Yellow-zinc, Grade 8, Hex head cap screw	2
50183-HW	1/4"-20, Yellow-zinc, Grade 8, Hex nut	2
50183-HW	1/4", Yellow-zinc, Grade 8, Flat washer	4
50183-HW	1/4", Yellow-zinc, Grade 8, Lock washer	2
50183-HW	5/16"-18 X 1.0", Yellow-zinc, Grade 8, Hex head cap screw	2
50183-HW	5/16", Stainless steel, Flat fender washer	2
50183-HW	5/16", Yellow-zinc, Grade 8, Lock washer	2
50183-HW	1/2", Yellow-zinc, Grade 8, Lock washer	14
50183-HW	1/2", Yellow-zinc, Grade 8, Flat washer	14
50183-HW	1/2"-13 x 1.25", Yellow-zinc, Grade 8, Hex head cap screw	6
50183-HW	1/2"-13 X 3.5", Yellow-zinc, Grade 8, Hex head cap screw	8

## TOOLS REQUIRED

- Plastic panel pry tool
- 10mm socket wrench
- 13mm socket wrench
- 18mm socket wrench
- 24mm socket wrench
- 3/4" socket wrench
- 7/16" socket wrench
- 1/2" socket wrench
- 24mm open end wrench
- 18mm open end wrench
- Zip-ties

## ASSISTANCE

We recommend two people perform the installation as items are heavy and may need to be held in place while installing.

## ORGANIZATION

Disassemble the vehicle where you can catalog and store everything. We suggest labeling and bagging all the OEM bolts when removing from the vehicle. Failure to keep track of parts could lead to an inability to properly reinstall components.

# DISASSEMBLY

1. Using a plastic panel pry tool, remove the four (4) ribbed shank push pins from the under-hood shroud and remove the shroud. (Figure 1)



Figure 1

2. Using a 10mm socket wrench, remove the four (4) screws holding the grille to the core support. (Figure 2) There may be one (1) additional screw on either side of the grille depending on the year model of the vehicle. If your vehicle has these screws remove them using the 10mm socket wrench. (Figure 3)



Figure 2



Figure 3

3. Once all the screws have been removed, finish removing the grille by firmly pulling outward from the top of the grille to release the push pins at the lower inside of the grille. (Figure 4-5) Depending on the year model of the vehicle there may be two (2) push pins or there may be four (4). Use the same process to remove both.



Figure 4



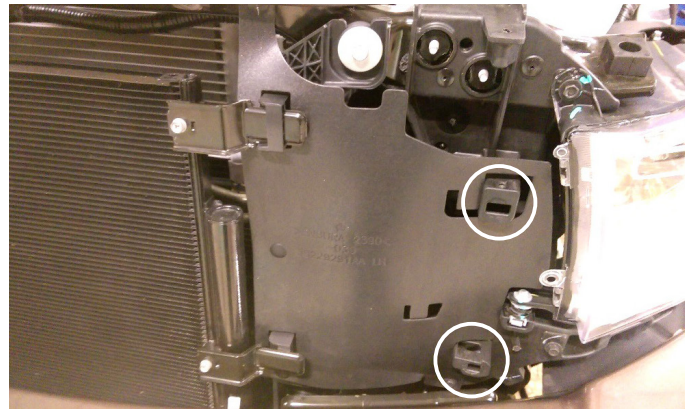

Figure 5

4. Disconnect the two (2) electrical connectors inside the driver side of the bumper by depressing the tab and separating the two (2) pieces of each connector. (Figure 6)



Figure 6

5. Using an 18mm socket wrench and an 18mm open end wrench, remove the four (4) nuts per frame rail that hold the bumper shell to the frame horns. (Figure 7)

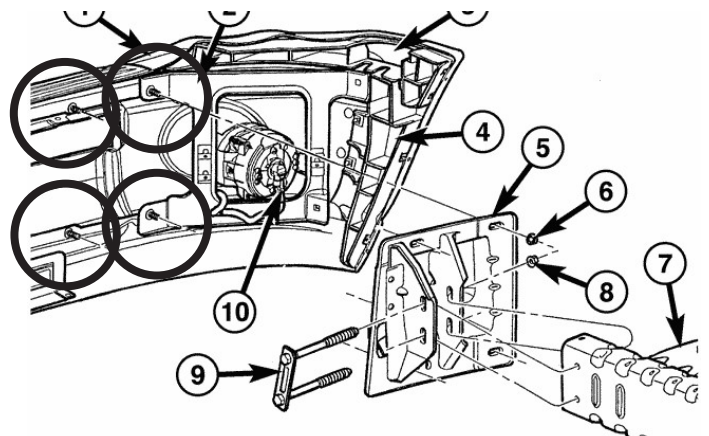

Figure 7

6. Using a 13mm socket wrench, remove the two (2) screws on either side of the intercooler that attach the intercooler supports to the frame rails. (Figure 8)

7. Using a 10mm socket wrench, remove the four (4) screws holding the intercooler shroud to the front of the intercooler and remove the shroud.

8. Using a 13mm socket wrench, loosen the clamps at the inlet and outlet of the intercooler to remove the intercooler from the vehicle. (Figure 9-10)



Figure 8

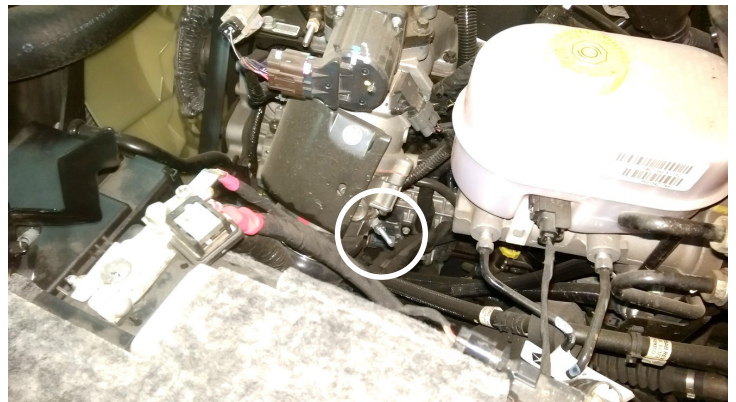

Figure 9

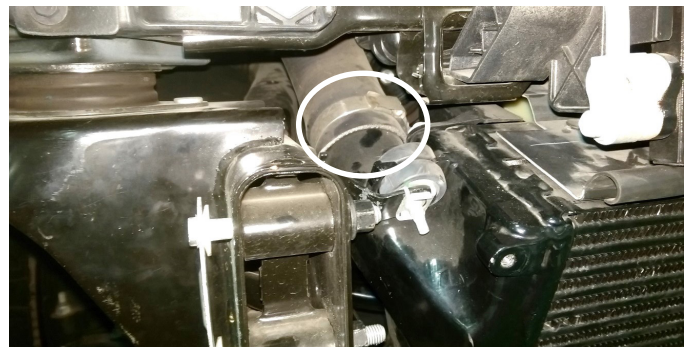

Figure 10

9. Using the plastic body panel pry tool, remove the parking sensors with its harness from the bumper. Begin by removing the strap by spreading it away from the tabs on the housing. Then, spread the housing itself and pull out on the sensor body. Finally, pull the sensor housing out of the bumper from the front. (Figure 11)



Figure 11

10. Using an 18mm socket wrench, remove the two (2) bolt strips per frame horn to remove the frame horns from the frame rails. (Figure 12, #9)

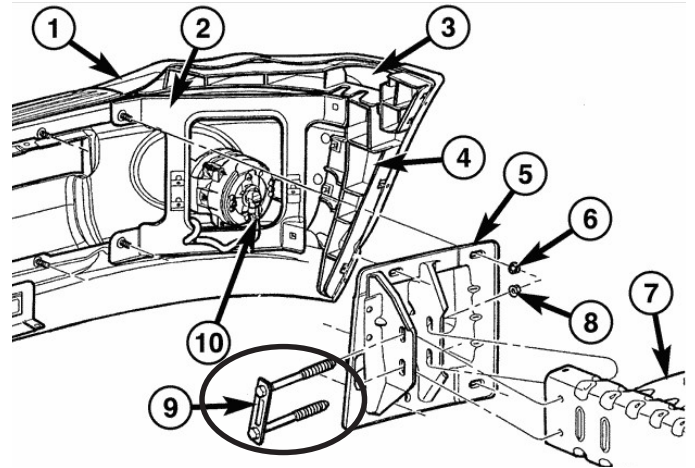

Figure 12

11. Using a 24mm socket wrench and 24mm open end wrench, remove the two (2) bolts per frame rail holding the underrun guards to the frame rail. (Figure 13)



Figure 13

# INSTALLATION

12. If installing any accessory lighting, do so now per the lighting manufactures instructions. There are two (2) light bar brackets (21871-10) and two (2) 1/4" yellow-zinc, grade 8 bolt stacks (50183-HW) provided for installing a 30" light bar. You will use the 7/16" socket wrench to install these.

13. Install the parking sensors into the new Fab Fours bumper at this time by reversing the process used to remove them in step 9. With the sensors installed in the bumper, apply a pea size drop of the provided epoxy around the sensor housing on the inside of the bumper. (Figure 14). Use the tabs welded in the bumper under each winch access hole to zip-tie the harness up away from the winch



Figure 14

14. Reinstall the intercooler at this time reversing the process used in steps 6-8.

15. Using a 3/4" socket wrench, loosely install the provided winch tray (21899) to the frame. Install the eight (8) provided 1/2"-13 x 3.5" yellow-zinc, grade 8 bolts with flat and lock washers (50183-HW) and the provided nut plates (21922). The triangle cutout in the nut plate should face up. (Figure 15-16)

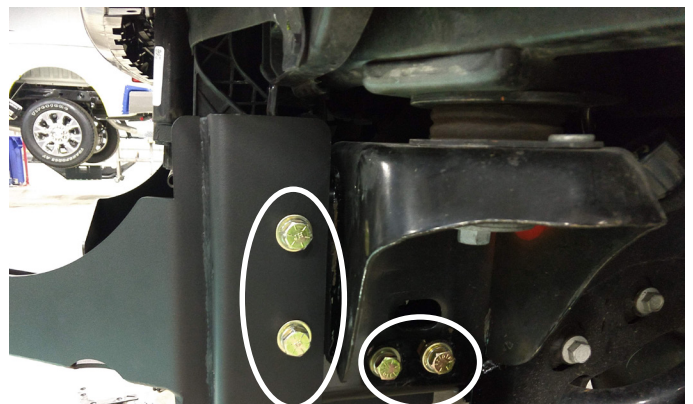

Figure 15



Figure 16

16. If installing a winch, do so now per the winch manufactures instructions.

17. Using a 3/4" socket wrench, loosely install the bumper (21898) to the winch tray (21899) with the provided six (6) 1/2"-13 x 1.25", yellow-zinc, grade 8 bolts and flat and lock washers (50183-HW). (Figure 17)



Figure 17

18. With assistance, lift the bumper into place on the vehicle so that the gap between the body and bumper top are roughly 3/8" and tighten all the hardware installed in steps 15 and 17)

**19. Install the provided light box (21900) into the driver side of the bumper (21898) from the backside being careful not to scratch the coating. Bring the box straight in and up. The box tabs in at the top and bolts at the bottom using the provided 5/16" bolts, lock washer, and fender washer (50183-HW). Tighten using a 1/2" socket wrench. (Figure 18-20)**



*Figure 18*



*Figure 19*



*Figure 20*

**20. Repeat step 19 on the passenger side with the other provided light box (21901) and remaining 5/16" hardware (50183-HW).**