



INSTALLATION MANUAL
MATRIX FRONT BUMPER
PRODUCT NUMBER: X425X
APPLICATION: 2019 DODGE RAM 1500



IMPORTANT SAFETY GUIDE | Your safety and the safety of others is very important.

In order to help you make informed decisions about safety, we have provided the following warnings, safety precautions, installation instructions, and other important information to alert you to potential hazards that could hurt you or others.

Please do a job safety analysis before each task to identify potential hazards for your situation and remove/protect against them. Use own good judgment and take your time.

Check packaged materials immediately upon arrival to ensure that all listed parts are included and undamaged.

Read and understand all warnings, safety precautions, and instructions before installing this product.

SENSORS FIELD OF VIEW WILL BE ALTERED WITH USE OF THE REPLACEMENT BUMPER.

WARNINGS

- Failure to observe the following warnings and instructions provided in this manual could lead to severe injury and/or death.
- For professional installation only. Careless installation and/or operation can result in serious injury, death, and/or equipment damage. All liability for installation and use rests with the user or consumer.
- Fab Fours, Inc. only approves installing this product according to these written instructions with the hardware provided. Failure to install according to these instructions will invalidate the warranty. This includes, but is not limited to, using alternative installation methods, hardware, or materials.
- This product is for off road use only.

SAFETY PRECAUTIONS

- Always remove jewelry and wear eye protection.
- Always use extreme caution when jacking up a vehicle for work. Set emergency brake and use tire blocks. Locate and use the vehicle manufacturers designated lifting points. Use jack stands.
- Always use appropriate and adequate care in lifting components into place.
- Always ensure components will remain secure during installation and operation.
- Always wear safety glasses when installing this kit. A drilling operation will cause flying metal chips. Flying chips can cause serious eye injury.
- Always use extreme caution when drilling a vehicle. Always disconnect power before welding. Thoroughly inspect the area to be drilled (on both sides of material when possible) prior to drilling, and relocate any objects that may be damaged.
- Always use extreme caution when welding a vehicle. Thoroughly inspect the area to be welded (on both sides of material when possible) prior to welding, and relocate any objects that may be a fire hazard. When welding in a cab, make sure the interior surfaces are covered (e.g., welding blanket) and a fire extinguisher is at hand.
- Always use extreme caution when cutting and trimming during fitting.
- Always tighten all nuts and bolts securely per installation instructions.
- Always route electrical cables carefully. Avoid moving parts, components that become hot, and rough or sharp edges.
- Always insulate and protect all exposed wiring and electrical terminals.
- Perform regular inspections and maintenance on mounts and hardware.

TABLE OF CONTENTS

2	SAFETY / DISCLAIMER
3	TABLE OF CONTENTS
4	A MESSAGE FROM THE OWNER
5	GETTING STARTED
6	PROVIDED MATERIAL
8	DISASSEMBLY
12	INSTALLATION
15	CONTACT

A MESSAGE FROM THE OWNER



Fab Fours' was born out of a passion for customizing vehicles and a love for the outdoors. Our engineering team uses the latest 3D design software to turn new product ideas into reality. In our factory, designs come to life with the combination of cutting edge technology for metal cutting and forming and an American workforce that puts its' heart and pride into every product.

From design and manufacturing, to quality and delivery, Fab Fours' mission is to be the market leader for steel truck and jeep accessories. We make sure a quality product is delivered on time, more than expected, better than expected to our customers.

Enjoy your new Fab Fours product. Welcome to the family!

Ereg Higgs

FOUNDER, FAB FOURS

GETTING STARTED

Before you begin the installation process of your new Fab Fours product, we suggest laying out all materials and parts on a pad or protective surface.

Failure to fully account for all components before beginning installation may leave vehicle immobile until part is acquired. Refer to the next pages as an inventory check.

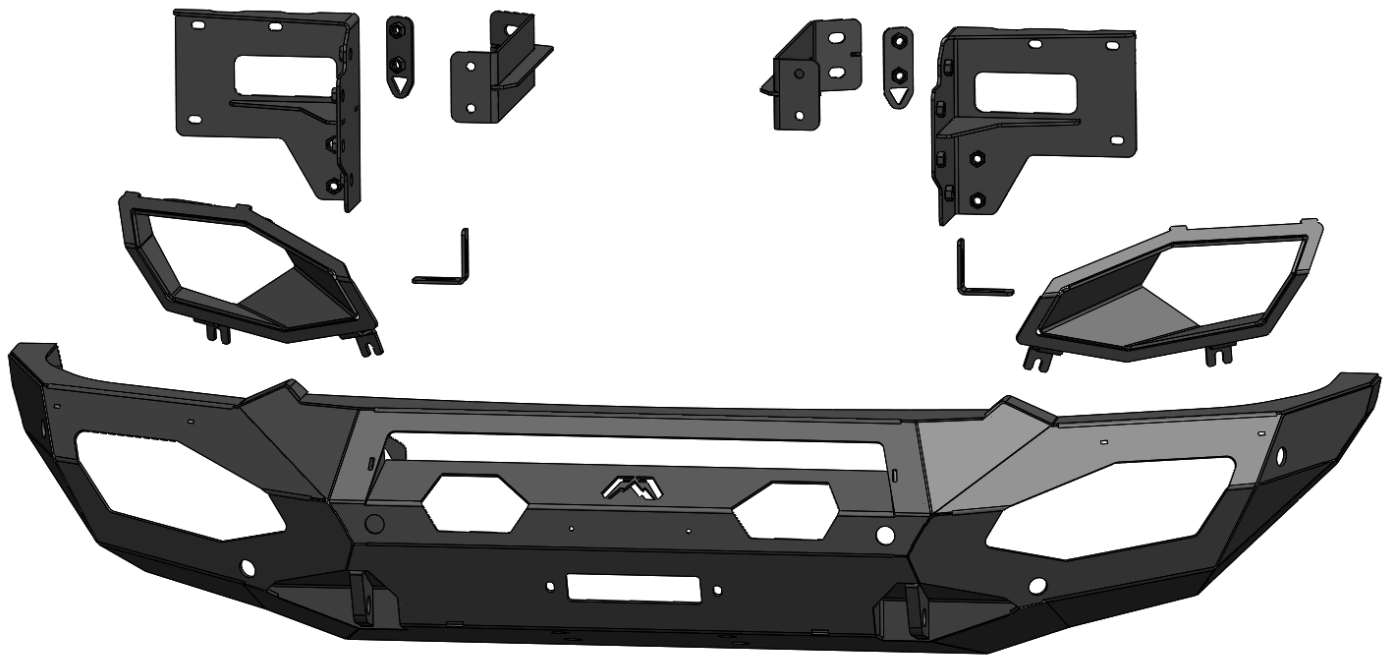

PROVIDED MATERIALS

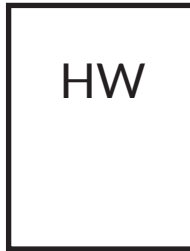

HW

50176-HW



IM

X425X-IM

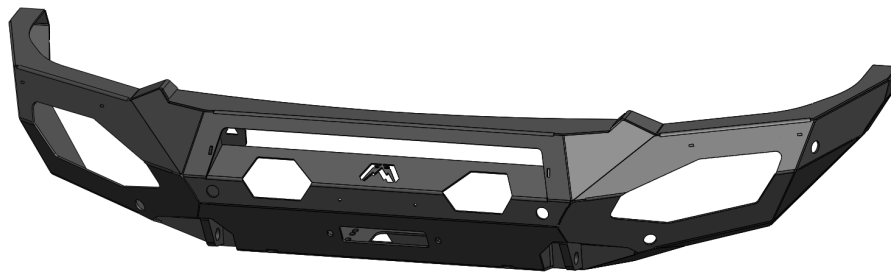

21851

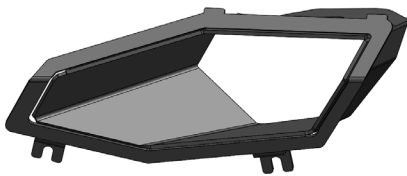

21852

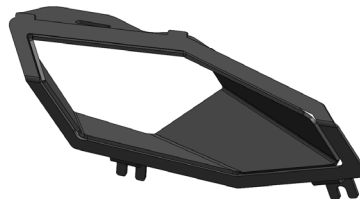

21853



21871
QTY: 2



21903
QTY: 2

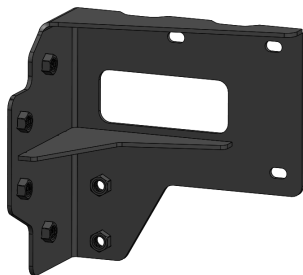

21864

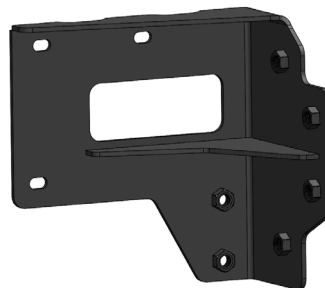

21865

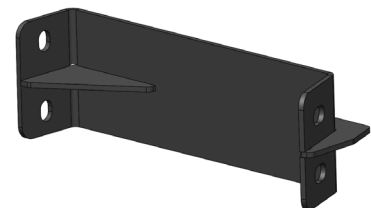

21902
QTY: 2

HARDWARE KIT | 50176

FAB FOURS IDENTIFICATION	COMPONENT DESCRIPTION	QTY
50176-HW	1/2"-13 x 1-1/4", Yellow Zinc Hex Cap Bolt, Grade 8	16
50176-HW	1/2", Yellow Zinc Flat Washer, Grade 8	16
50176-HW	1/2", Yellow Zinc Lock Washer, Grade 8	16
50176-HW	5/16"-18 x 1", Yellow Zinc Hex Cap Bolt, Grade 8	4
50176-HW	5/16", Stainless Steel, Fender Washer	4
50176-HW	5/16", Yellow Zinc Lock Washer, Grade 8	4
50176-HW	7/16"-14 x 1-1/4", Yellow Zinc Hex Cap Bolt, Grade 8	6
50176-HW	7/16", Yellow Zinc Flat Washer, Grade 8	12
50176-HW	7/16", Yellow Zinc Lock Washer, Grade 8	6
50176-HW	7/16", Yellow Zinc Hex Nut, Grade 8	6
50176-HW	1/4"-20 x 1", Yellow Zinc Hex Cap Bolt, Grade 8	2
50176-HW	1/4", Yellow Zinc Flat Washer, Grade 8	4
50176-HW	1/4", Yellow Zinc Lock Washer, Grade 8	2
50176-HW	1/4", Yellow Zinc Hex Nut, Grade 8	2

TOOLS REQUIRED

- Plastic panel pry tool
- Zip ties
- Snips
- (2) 7/16" socket wrench
- 1/2" socket wrench
- 5/8" socket wrench
- 11/16" socket wrench
- 3/4" socket wrench
- 10mm socket wrench
- 18mm socket wrench

ASSISTANCE

We recommend two people perform the installation as items are heavy and may need to be held in place while installing.

ORGANIZATION

Disassemble the vehicle where you can catalog and store everything. We suggest labeling and bagging all the OEM bolts when removing from the vehicle. Failure to keep track of parts could lead to an inability to properly reinstall components.

DISASSEMBLY

Note: Save all OEM parts until installation is complete!

1. Using a 10mm socket wrench, remove the five (5) 10mm OEM bolts located under both the passenger side and driver side wheel wells. Once the bolts have been removed, remove the plastic wheel well cover from the vehicle. (Figure 1-2)

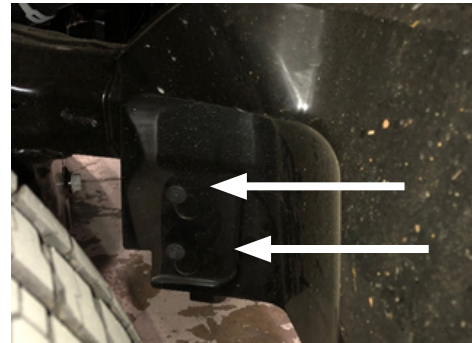

Figure 1



Figure 2

2. Locate the harness plug on the driver side of the vehicle and disconnect it. (Figure 3)

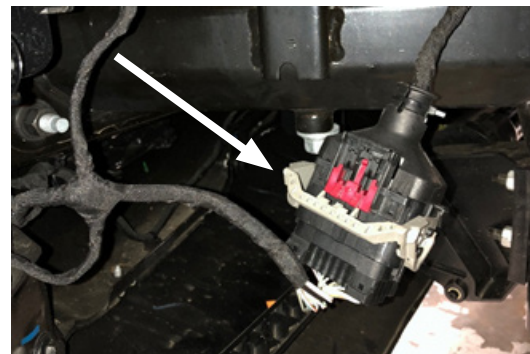

Figure 3

3. Using an 18mm socket wrench, remove the three (3) OEM nuts from the frame rails to disconnect the bumper from the truck. (Figure 4)

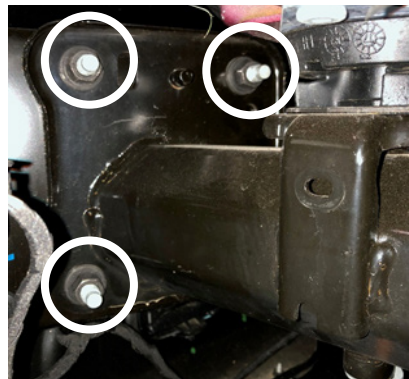

Figure 4

4. Remove the OEM bumper from the truck and set it aside.

5. Remove the OEM electrical harness from bumper by removing the push pins. (Figure 5-6)



Figure 5



Figure 6

6. Disconnect the electrical harness from the fog lights in the bumper. (Figure 7)



Figure 7

7. Remove the six (6) sensors from the sensor housing by expanding both sides of the sensor housing and lift up. (Figure 8-9)



Figure 8



Figure 9

NOTE: Document the location of each sensor housing and sensor for reference when reinstalling into your bumper.

NOTE: Sensors are extremely delicate and must be handled with care! Do not push on face of sensors to remove!

8. Remove the six (6) sensor housings from the bumper by depressing the four (4) tabs while pulling outward from the outside of the bumper. (Figure 10-11)

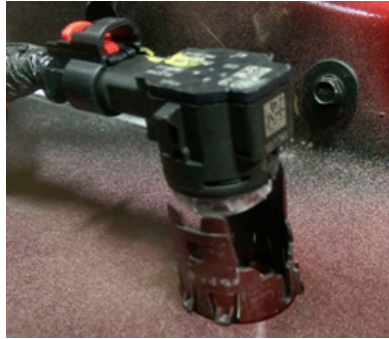

Figure 10



Figure 11

INSTALLATION

NOTE: it is always recommended to chase all projection nuts with their appropriate taps to clear out any foreign debris or powder coat. (Figure 12)

NOTE: steps 9 through 11 are only used if you are installing a 30" light bar and/or winch.

14. Using the included "L" brackets (21871) and the provided two (2) 1/4"-20 hex bolts, four (4) 1/4" flat washers, two (2) 1/4" lock washers, and two (2) 1/4"-20 hex nuts (50176-HW), loosely install the "L" brackets to the inside of the bumper (21851) hand tight.

15. Using the factory hardware for the 30" light bar, securely tighten the light bar to the "L" brackets following the manufactures steps and recommended tools.

16. Using a pair of 7/16" wrenches, center the light bar and fully tighten the provided two (2) 1/4"-20 bolt stacks. (50176-HW) (Figure 13)

17. Begin routing the factory wiring harness through the winch tray cutouts starting with the skinny end of the harness, starting at the driver side and finishing on the passenger side. (Figure 14)

18. Using a 1/2" socket wrench, install the light boxes (21852 and 21853) into the bumper by inserting the tabs into the slots and bolting it down with the provided four (4) 5/16"-18 hex bolts, and four (4) 5/16" stainless steel fender washers (50176-HW). (Figure 15)



Figure 12



Figure 13



Figure 14



Figure 15

NOTE: install the light boxes before reinstalling any of the wing sensors.

19. Reinstall the six (6) sensor housings with sensors with the orientation as shown. (Figure 16 and 17)

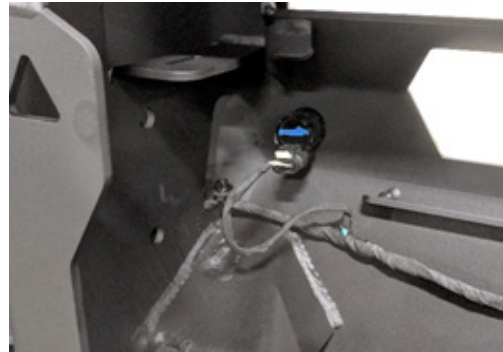

Figure 16



Figure 17

20. Snip off the four (4) factory panel clips from the center of the wiring harness. (Figure 18)

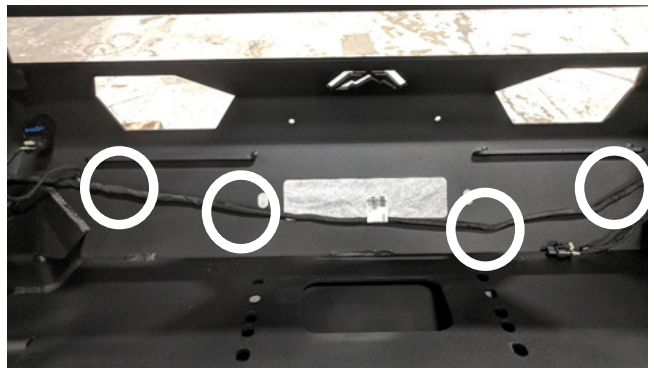

Figure 18

21. Begin zip tying the factory wiring harness starting at the center and working your way to out outer wings. (Figure 19- 20)



Figure 19



Figure 20

22. If applicable, fully install your winch into the bumper at this time while following the manufactures instructions and using the recommended tools.

23. Hand tighten both frame end brackets to the vehicles frame rails using the provided six (6) 7/16"-14 hex bolts, twelve (12) 7/16" flat washers, six (6) 7/16" lock washers, and six (6) hex nuts. (50176-HW) (Figure 21 and 22)

NOTE: the 7/16"-18 bolt stacks should be positioned so that the head of the bolt with flat washer are on the front side of the bracket and the flat washer, lock washer, and hex nut are on the back side of the frame rail end. This allows for the proper clearance needed for bumper installation.



Figure 21



Figure 22

24. With assistance, lift and support the bumper up to the vehicle and between the frame end brackets.

25. Tighten the provided eight (8) 1/2"-13 hex bolts, eight (8) 1/2" lock washers, and eight (8) 1/2" flat washers. (50176-HW) (Figure 23)



Figure 23

27. Center and align the bumper to the vehicle and fully tighten all 7/16"-14 hardware securing your frame rail brackets to the vehicle frame rail. (50176-HW)

28. Loosely install each bracket stiffener and nut plate (21902, 21903) to both brackets (21864 & 21865) and each frame crash bar using the eight (8) provided 1/2"-13 hex bolts, eight (8) 1/2" flat washers, and eight (8) 1/2" lock washers. (50176-HW)(Figure 24-25)



Figure 24



Figure 25

29. Using a 3/4" wrench, fully tighten the remaining eight (8) 1/2"-13 hardware.