



Installation Instructions
817853
2019-21 GM SIERRA/SILVERADO 1500
5.3L ENGINE
Crew Cab & Double Cab
 Except Crew Cab 2 Wheel Drive with 2 piece driveshaft

OVERVIEW:

1. Take a moment to read and understand these instructions before installing your Flowmaster performance system.

NOTE: Please inventory all parts now before continuing and if necessary, report any missing items to our tech line. This will avoid potentially stranding your vehicle until any missing replacement parts arrive.

ITM #	PART #	DESCRIPTION	QTY.
8	86570S	Rear Exit Pipe	2
9	ST461	Tips	2
N/A	PK989	Hardware Package includes:	1
10	226HA	Left Rear Frame Hanger	1
11	HA566	Backing Plates	2
12	HA168	Rubber Hanger	1
13	MC250BS	2½" Band Clamp	5
14	MC300BS	3" Band Clamp	2
15	HW220	¾"-16 x 4" Bolt	1
16	HW303	¾" Flat Washer	1
17	HW309	¾" Lock Washer	1
18	HW103	¾" Nut	1
19	HW502	7/16" Hanger Keepers	2
20	HW503	½" Hanger Keepers	4
21	HW505	15" Zip Ties	1

ITM #	PART #	DESCRIPTION	QTY.
1	26742S	Inlet Pipe	1
2	TB700S	Extension Pipe	1
3	8530452-Z	AMT Muffler	1
4	86566S	Left Front Tailpipe	1
5	86568S	Left Rear Tailpipe	1
6	86567S	Right Tailpipe	1
7	86569S	Side Exit Pipe	2

PREPARE VEHICLE FOR KIT INSTALLATION:

2. Raise vehicle up on a hoist or rack to working height. If you don't have access to a hoist or rack, support vehicle with jack stands.

WARNING:
 Avoid serious burns! Allow your vehicle time to cool completely before touching any factory engine components.

To ease preparation and installation of your new kit:

- Apply penetrating lubricant to mounts, bolts and clamps before you remove them.
- Use stands as necessary to support parts as you detach them from your vehicle and again as you install new parts.

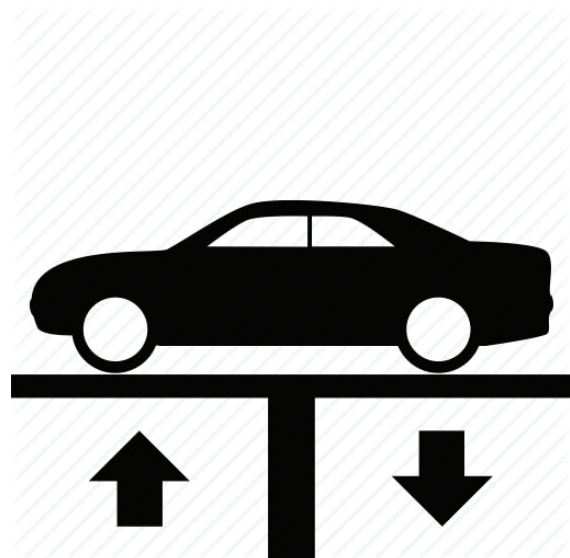

3. Cut tailpipe at muffler exit. Disassemble hanger wires from isolators and remove tailpipe section from vehicle.



4. Support muffler and disassemble wire hangers from isolators. Loosen ball clamp, disconnect inlet pipe at cat. converter and remove exhaust system. Release tab to remove clamp from pipe and retain it for later use.

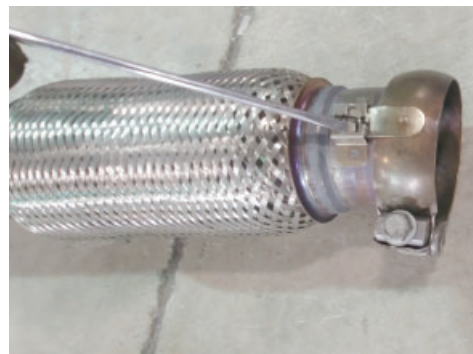

INSTALL FLOWMASTER EXHAUST SYSTEM

5. Remove nuts from stock and Flowmaster clamps, apply anti-seize compound to bolts and re-install nuts.

NOTE: The image in this step is intended for illustrative purposes only and may or may not accurately reflect components included in your kit.



6. Find your vehicle within specifications listed below, and if necessary, apply corresponding modifications to ensure it will install properly.

WHEEL BASE	BODY STYLE	BED LENGTH	INLET ASSY:
148"	Crew Cab	5'8	Inlet Pipe only
157"	Crew Cab	6'5	Inlet+Extension
148"	Double Cab	6'5	Inlet Pipe only

7. Place factory ball clamp (removed step 4) onto **inlet pipe (1)** then connect it to catalytic converter. Insert wire hanger in isolator and tighten clamp enough to allow for adjustment.

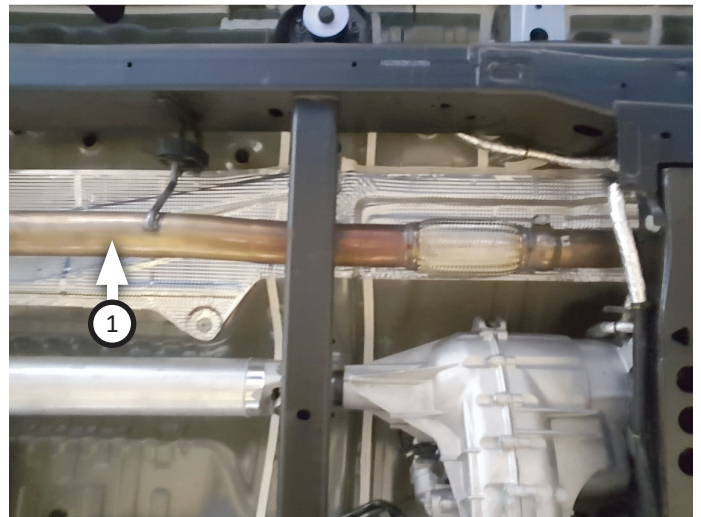

8. If applicable, place **clamp (14)** onto **extension (2)** then connect it to inlet pipe. Tighten clamp just enough to allow for adjustment.

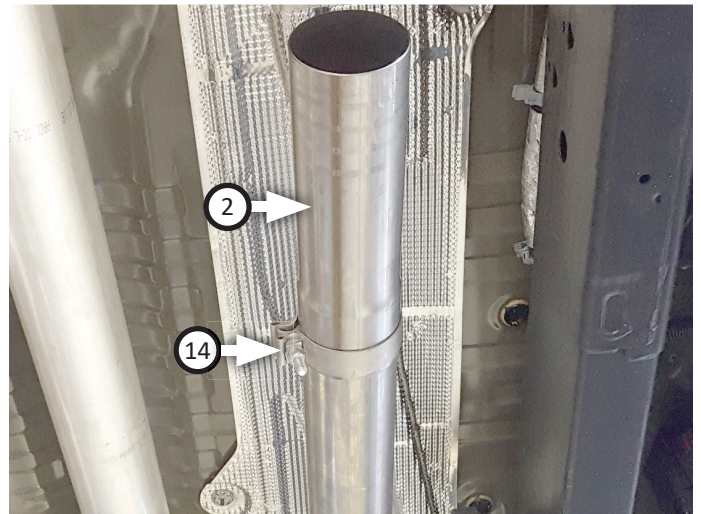

9. Place **clamp (14)** onto **muffler (3)** then connect it to inlet or extension pipe. Tighten clamp just enough to allow for adjustment then place (x2) **clamps (13)** onto muffler outlets.

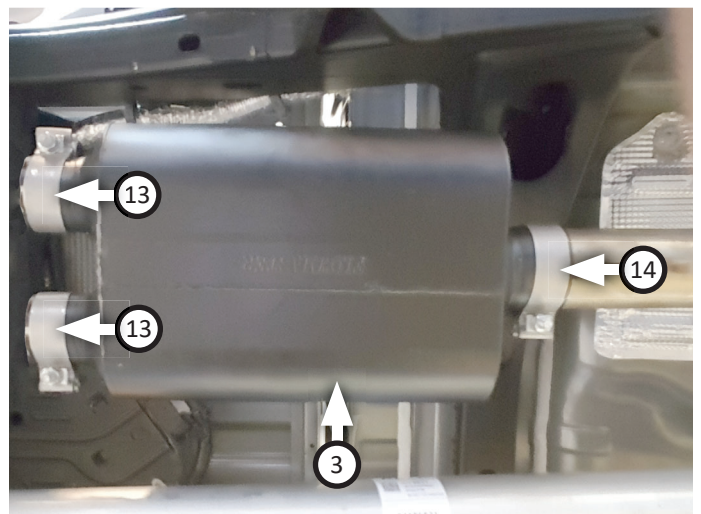

10. Fasten **left rear frame hanger (10)** to vehicle using **bolt (15)**, (**x2**) **backing plates (11)**, **flat washer (16)**, **lock washer (17)** and **nut (18)** as shown. Then hang **rubber hanger (12)** on frame hanger end.

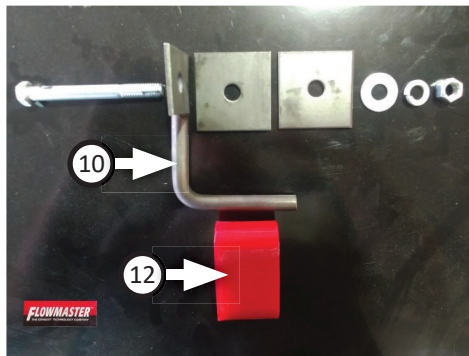

11. Route **left front (4)** and **right tailpipes (6)** over axle then connect them to muffler. Insert wire hangers into isolators then tighten clamps just enough to hold parts.

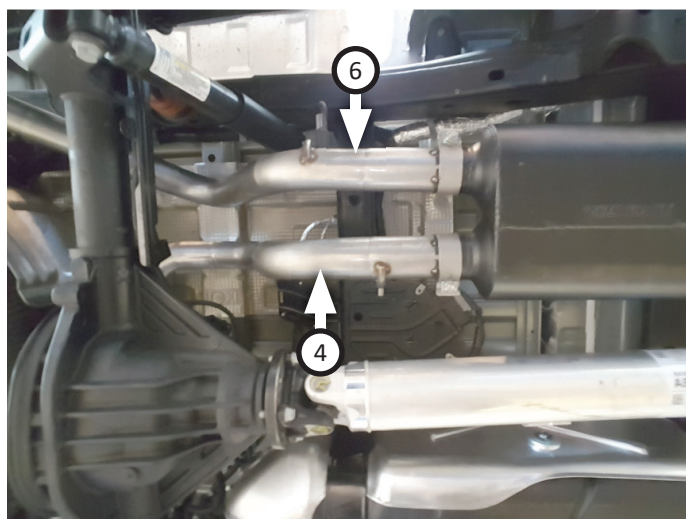

12. Place **clamp (13)** onto **left rear tailpipe (5)** then connect it to left front tailpipe. Insert wire hanger into rubber hanger then tighten clamp just enough to allow for later adjustment.

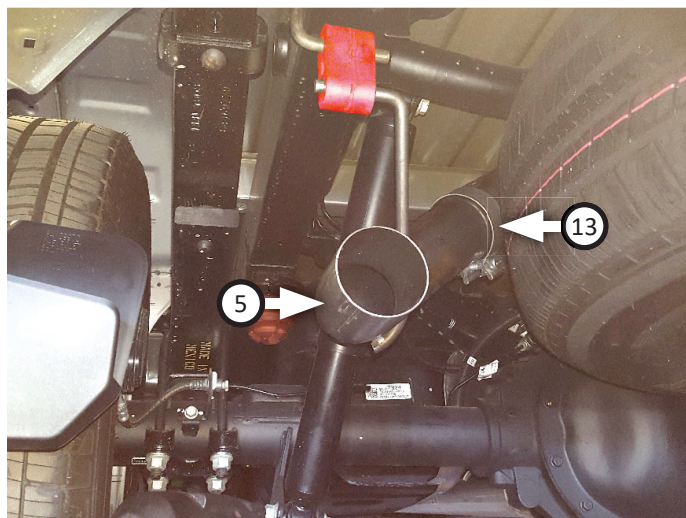

NOTE: For a side exit exhaust, complete this step using (x2) **side exit pipes (7)** in place of rear exit pipes.

13. Place (x2 ea.) **clamps (13)** onto **rear exit pipes (8)** connect them to tailpipes and tighten clamps.

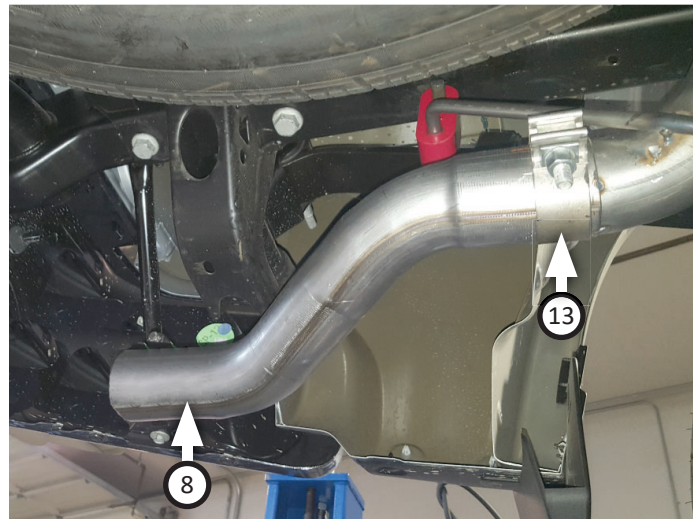
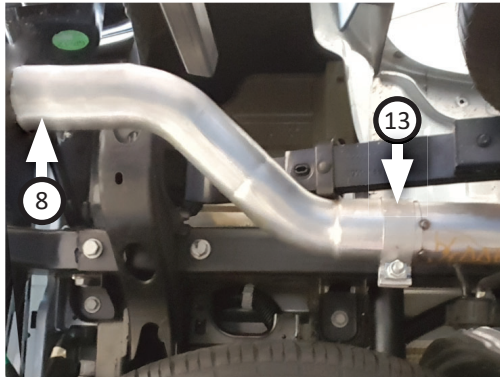

14. Place (x2) **tips (9)** onto exit pipes and tighten inlets. Rotate exit pipes and tips to desired distance from body or bumper, so angle cut on tips are properly positioned.
15. Adjust exhaust components for fit; maintaining $\frac{1}{2}$ " clearance and compensating for suspension, travel and vibration. Secure vent hose and brake lines away from heat with **zip tie (21)** then tighten all clamps.
16. Fit $\frac{7}{16}$ " (19) and $\frac{1}{2}$ " (20) **hanger keepers (x6)** onto each sideways hanger.
17. Recommended: Secure slip-fit connections with a 1-inch tack weld then spray high-temp paint over each weld to prevent rust and premature corrosion.



Congratulations, the installation of your FLOWMASTER performance exhaust system is now complete!





Installation Instructions
817853
2019-21 GM SIERRA/SILVERADO 1500
5.3L ENGINE
Crew Cab & Double Cab
Except Crew Cab 2 Wheel Drive with 2 piece driveshaft

