

Load**LIFTER** 5000™ **ULTIMATE**

ADJUSTABLE AIR HELPER SPRINGS

TOW AND HAUL WITH SAFETY AND COMFORT™



Kit 88229

Nissan Titan XD

2WD/4WD

INSTALLATION GUIDE

For maximum effectiveness and safety, please read these instructions completely before proceeding with installation.

Failure to read these instructions can result in an incorrect installation.

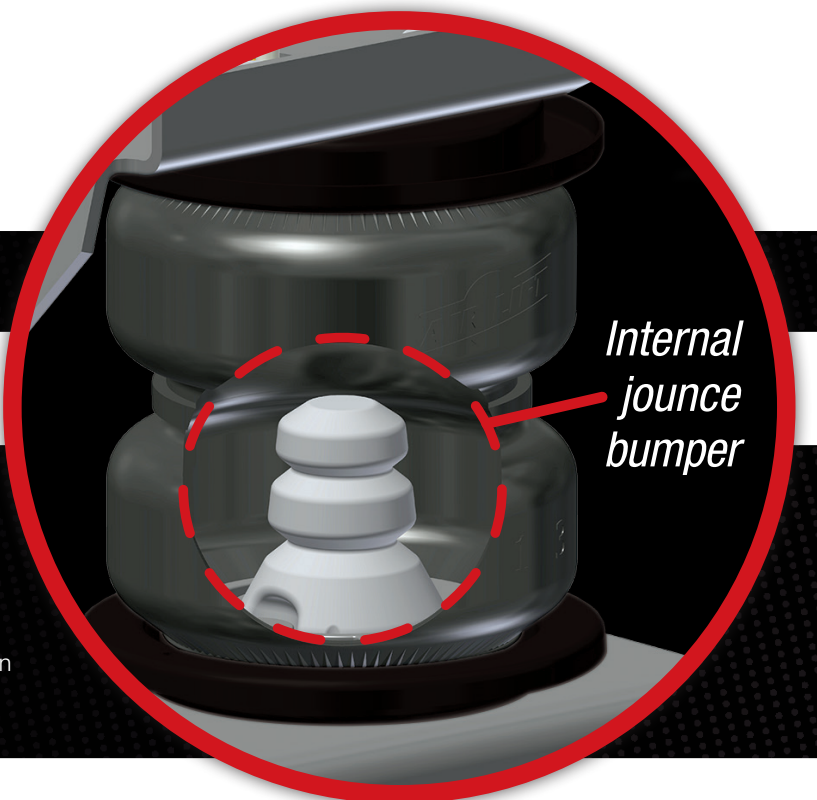

TABLE OF CONTENTS

A. Installation Diagram	2
B. Hardware and Tools List	3
Hardware List	3
Tools List	3
C. Introduction	4
Important Safety Notice	4
Notation Explanation	4
D. Installing the LoadLifter 5000 Ultimate System	5
Getting Started	5
Assembling the Air Spring	9
Installing the Assemblies	11
E. Installing the Air Lines	16
Installing Nylon Air Lines	16
F. Finished Installation	17
Installation Checklist	18
G. Maintenance and Use Guidelines	18
Minimum and Maximum Pressure	18

A. Installation Diagram

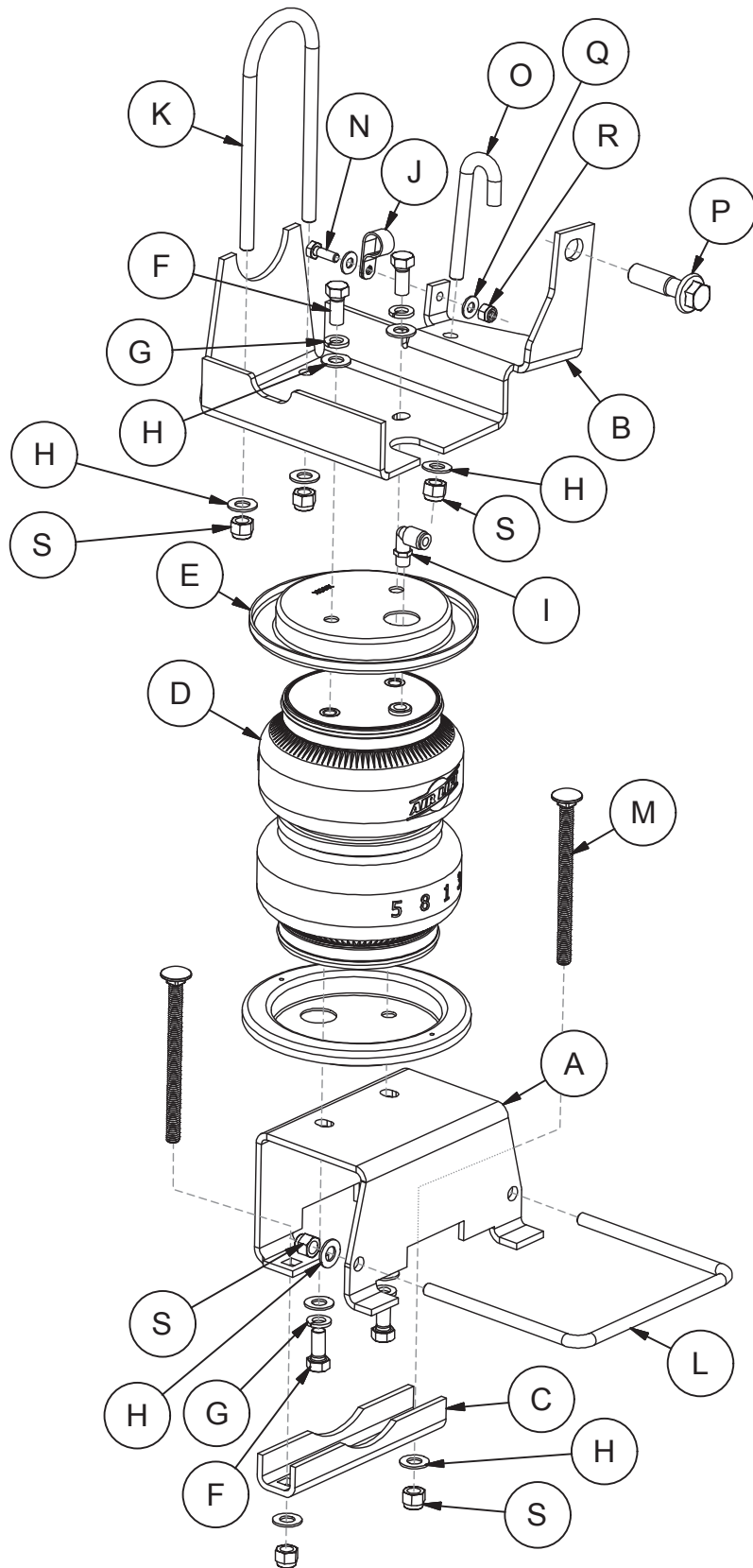

fig. A.1

B. Hardware and Tools Lists

HARDWARE LIST

Item	Part #	Description	Qty
A	03912	Lower bracket	2
B1	07802	L.H. upper bracket	1
B2	07903	R.H. upper bracket	1
C	01531	Axle clamp bar	2
D	58496	Air spring	2
E	11967	Roll plate	4
F	17203	3/8"-24 x 7/8" Hex cap screw	8
G	18427	3/8" Lock washer	8
H	18444	3/8" Flat washer	26
I	21837	90 degree Swivel elbow fitting	2
J	10976	P-clamp	2
K	11520	U-bolt, round	2
L	11717	U-bolt, square	2
M	17166	3/8"-16 x 4" Carriage bolt	4
N	17261	1/4"-20 x 3/4" Hex-head screw	2
O	17309	3/8"-16 x 3.75" J-bolt	2
P	17508	M14-1.5 x 40 Hex flange bolt	2
Q	18419	#12 Flat washer	4
R	18425	1/4"-20 Nylon lock nut	2
S	18435	3/8"-16 Nylon lock nut	18
T*	11543	EVAP control valve bracket	1
AA*	20086	Hose assembly	1
BB*	10466	Zip tie	6
CC*	18501	5/16" Flat washer	2
DD*	18411	Star washer	2
EE*	21230	Valve cap	2
FF*	21233	5/16" Hex nut	4
GG*	21234	Rubber washer	2

* not shown in installation diagram

TOOLS LIST

Description	Qty
Metric and STD open-end box wrenches	set
Ratchet with metric and STD sockets.....	set
Drill and 5/16" drill bit.....	1
Torque wrench.....	1
Hose cutter, razor blade or sharp knife	1
Hoist or floor jack	1
Safety stands.....	2
Safety glasses	1
Air compressor or compressed air source	1
Spray bottle with dish soap/water solution.....	1
Blue (medium strength) threadlocking compound	1

C. Introduction

The purpose of this publication is to assist with the installation, maintenance and troubleshooting of the LoadLifter 5000 Ultimate air spring kit. LoadLifter 5000 Ultimate utilizes sturdy, reinforced, commercial grade single or double, depending on the kit, convolute bellows. The bellows are manufactured like a tire with layers of rubber and cords that control growth. LoadLifter 5000 Ultimate kits are recommended for most 3/4- and 1-ton pickups and SUVs with leaf springs and provide up to 5,000 pounds of load leveling support with air adjustability from 5-100 PSI. The kits are also used in motor home rear kits and some motor home fronts where leaf springs are used.

It is important to read and understand the entire installation guide before beginning installation or performing any maintenance, service or repair. The information here includes a hardware list, tool list, step-by-step installation information, maintenance guidelines and operating tips.

Air Lift Company reserves the right to make changes and improvements to its products and publications at any time. For the latest version of this manual, contact Air Lift Company at **(800) 248-0892** or visit airliftcompany.com.

IMPORTANT SAFETY NOTICE

The installation of this kit does not alter the gross vehicle weight rating (GVWR) or payload of the vehicle. Check your vehicle’s owner’s manual and do not exceed the maximum load listed for your vehicle.

Gross vehicle weight rating: The maximum allowable weight of the fully loaded vehicle (including passengers and cargo). This number — along with other weight limits, as well as tire, rim size and inflation pressure data — is shown on the vehicle’s Safety Compliance Certification Label.

Payload: The combined, maximum allowable weight of cargo and passengers that the truck is designed to carry. Payload is GVWR minus the base curb weight.

NOTATION EXPLANATION

Hazard notations appear in various locations in this publication. Information which is highlighted by one of these notations must be observed to help minimize risk of personal injury or possible improper installation which may render the vehicle unsafe. Notes are used to help emphasize areas of procedural importance and provide helpful suggestions. The following definitions explain the use of these notations as they appear throughout this guide.



INDICATES IMMEDIATE HAZARDS WHICH WILL RESULT IN SEVERE PERSONAL INJURY OR DEATH.



INDICATES HAZARDS OR UNSAFE PRACTICES WHICH COULD RESULT IN SEVERE PERSONAL INJURY OR DEATH.



INDICATES HAZARDS OR UNSAFE PRACTICES WHICH COULD RESULT IN DAMAGE TO THE MACHINE OR MINOR PERSONAL INJURY.

NOTE

Indicates a procedure, practice or hint which is important to highlight.

D. Installing the LoadLifter 5000 Ultimate System

GETTING STARTED

1. Raise the vehicle and support it using safety stands or equivalent, so the axle can be safely dropped away from the frame. This is necessary in order for the air spring assembly to be put into position between the axle and frame (Fig. D.1). The vehicle is shown on a drive-on hoist with the axle supported.



fig. D.1

2. It will be necessary to pull the plastic harness fasteners away from the frame on the wiring harness behind the axle on both the passenger's (right) and driver's (left) side so that the harness is loose from the frame (Fig. D.2).



fig. D.2

3. Unbolt and pull aside the frame vent tube bracket and the vent tube itself so that it is away from the frame. This will be reattached later in the installation (Fig. D.3).

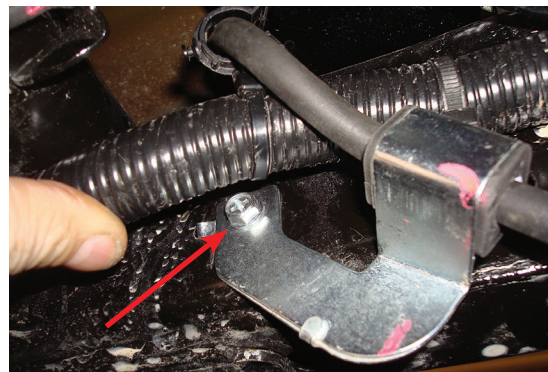

fig. D.3

- Remove the rear 5th-wheel hitch frame bolts and discard bolt. (Fig. D.4).



fig. D.4

- Remove the ABS lines from the brackets on the driver's (left) and passenger's (right) side axle (Fig. D.5).



fig. D.5

- On the driver's (left) side line, loosen the left bolt that holds the rear brake line to the rear axle bracket. Rotate the brake line counter clockwise as far as it will go. Tighten the brake line bolt so the line stays in this position (Fig. D.6). This is done to gain clearance for the lower bracket.

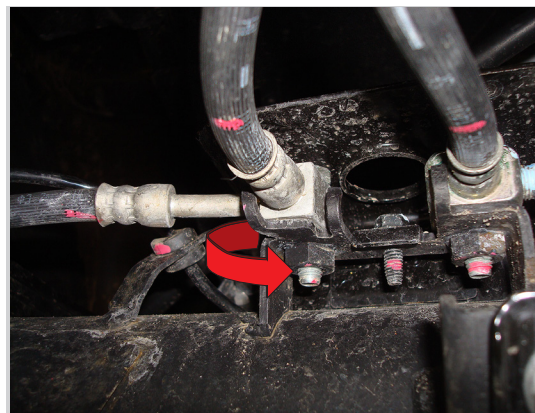

Loosen the bolt holding the brake line to the axle bracket and rotate the brake line counterclockwise as far as it can go. Tighten the brake line bolt so the line stays in this position.

fig. D.6

7. FOR GAS MODELS ONLY: pull up on the EVAP control valve to remove it from the frame bracket that holds it into position (Figs. D.7 & D.8). Bend the “fingers” on the bracket inboard and down as shown using a pair of channel lock pliers or equivalent. Let the EVAP control valve hang at this time.



fig. D.7



fig. D.8

8. In the large hole on the inside of the frame rail, just behind the round crossmember, insert the J-bolt (O) into the large hole on both the driver's (left) and passenger's (right) sides (Figs. D.9 & D.10).



fig. D.9

Driver's (left) side



fig. D.10

Passenger's (right) side

9. Install the lower bracket/spring perch U-bolt (L) by first inserting it around the spring perch, forward of the axle. Then, rotate it around the back side of the perch, making sure that the U-bolt fits in between the ABS line/bracket and the spring (Figs. D.11, D.12 & D.13).



fig. D.11

Start U-bolt from the front side of the axle and rotate backward around the spring perch.



fig. D.12

Make sure U-bolt goes between the ABS line/bracket and the leaf spring.

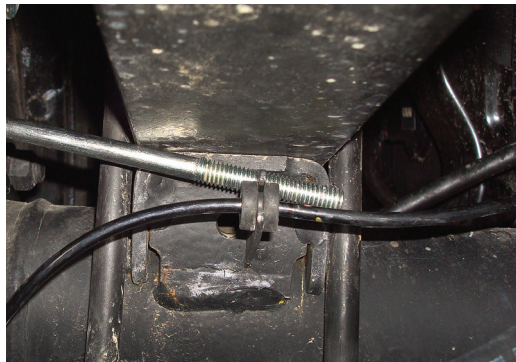

fig. D.13

U-bolt in position for use on the lower bracket.

10. Set the round U-bolt (K) into position over the round crossmember located above the axle (Fig. D.14) on both the driver's (left) and passenger's (right) side.

NOTE

Make sure not to pinch the lines that are on the driver's (left) side, above the crossmember.



Set the round U-bolts around the cross member over the axle, as shown, on both driver's (left) and passenger's (right) sides. Be careful not to pinch any wiring that may be in the area on the driver's (left) side.

fig. D.14

ASSEMBLING THE AIR SPRING

1. Set a roll plate (E) on top of the air spring (D). The radiused, or rounded, edge of the roll plate should be toward the air spring so that it is seated inside the roll plate (Fig. D.15). Install the 90 degree swivel fitting (I) into the top of the air spring, making sure that it is finger-tight plus one and a half turns.

*fig. D.15*

2. Set both upper brackets (B1 & B2) onto the top of the air springs and attach with two 3/8"-16 x 7/8" hex-cap screws (F), 3/8" lock washers (G) and 3/8" flat washers (H) (Fig. D.16). Leave loose at this time.

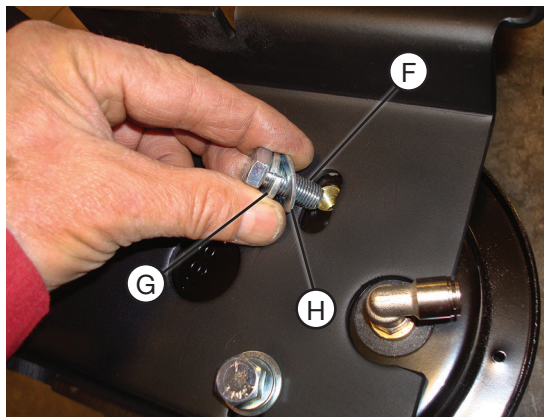
*fig. D.16*

3. Flip the assembly upside down and set a roll plate on the bottom of the air spring (Fig. D.17).

*fig. D.17*

4. Install the lower brackets (A) onto the air spring assembly with two 3/8"-16 x 7/8" hex cap screws (F), 3/8" lock washers (G) and 3/8" flat washers (H) (Fig. D.18), making sure that the flanges on the lower bracket face the fitting on the top of the air spring. (Fig. D.19).

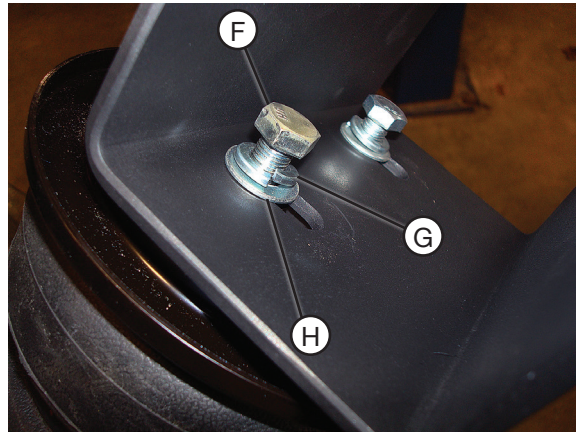
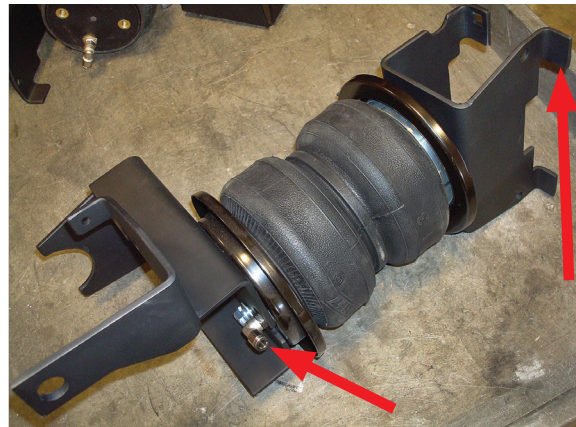

fig. D.18



The flanges on the lower bracket must face the same direction as the fitting on the upper assembly.

fig. D.19

5. Figure D.20 shows the driver's (left) and passenger's (right) side assemblies.

Driver's (left) side



Passenger's (right) side

fig. D.20

INSTALLING THE ASSEMBLIES

1. Drop the axle down low enough in order to set the assemblies into position onto the axle just inside the leaf spring, then set the assemblies in place.

NOTE

The air fitting on the assemblies face outboard (tire side) of the vehicle.

2. If necessary, raise the axle up just enough that the upper bracket touches the frame. While raising the axle, align the J-bolt and round U-bolts with the holes in the bracket (Fig. D.21). Attach the upper bracket to the 5th-wheel mounting hole, located on the side of the frame using the M14-1.5 X 40 hex flange bolt (P). Apply medium strength (blue) threadlocker compound to the bolt before inserting in hole.

Install M14 bolt with blue threadlocker compound through the upper bracket and into the existing hole in the frame.

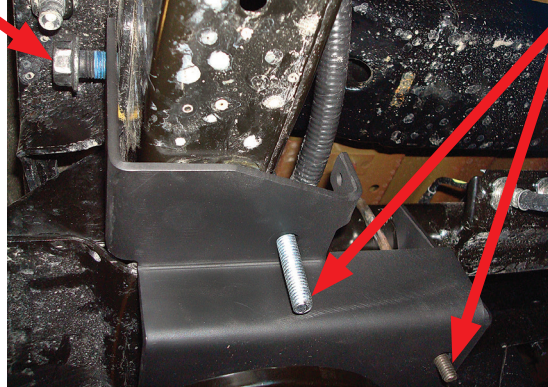

While raising the axle, once the assemblies are in place, align the J-bolt and round U-bolt with the corresponding holes in the upper brackets.

fig. D.21

3. Cap the J-bolt and round U-bolt with three 3/8" flat washers (H) and nylon lock nuts (S) (Fig. D.22).

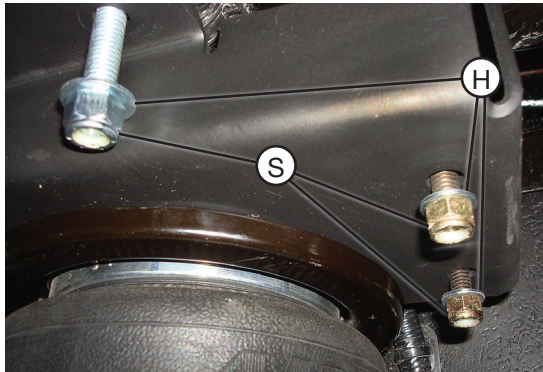

fig. D.22

4. Snug the M14 bolt first, then torque the 3/8" U-bolt and J-bolt evenly to 15 lb.-ft. (20 Nm) Then torque the M14 hardware to 77 lb.-ft. (105Nm).

- Attach the lower bracket by inserting the legs of the previously installed U-bolt around the spring perch, through the corresponding holes in the lower bracket (Fig. D.23).

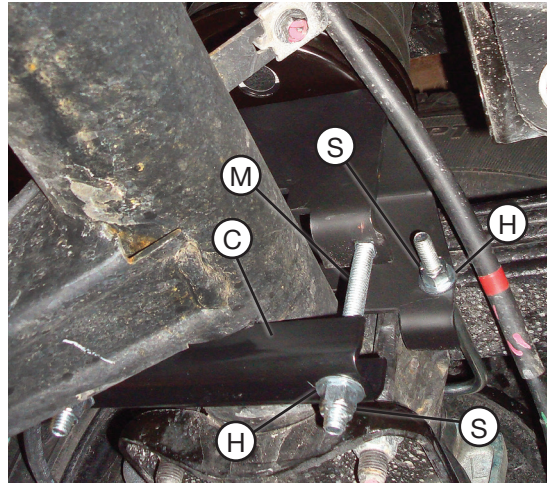
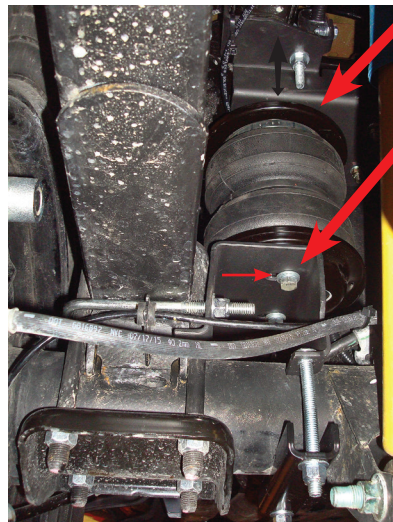

fig. D.23

- Insert the two 3/8"-16 x 4" carriage bolts (M) through the holes in the lower bracket and install the lower axle clamp bar (C) under the axle. Cap the carriage bolts with two 3/8" flat washers (H) and 3/8"-16 nylon lock nuts (S). Do not tighten at this time.
- Push the lower bracket up against the stock leaf spring U-bolts, making sure the tabs on the lower bracket are locked around the outside of the U-bolts and snug the spring perch/lower bracket U-bolt evenly (Do not tighten at this time). Tighten the axle spring clamp evenly until tight, then torque the axle clamp hardware to 15 lb.-ft. (20Nm). Torque the spring perch/lower bracket hardware to 15 lb.-ft. (20Nm).
- In final adjustments, push the lower bellows inboard on the lower bracket and tighten the lower hardware to no more than 20 lb.-ft. (27Nm) (Fig. D.24).



- Push the bellows forward or backward and tighten the mounting hardware.
- Push the bellows inboard and tighten the mounting hardware.

fig. D.24

9. Align the upper bellows by moving it forward or backward, then tighten the upper mounting hardware no more than 20 lb.-ft. (27Nm).
10. FOR DIESEL MODELS ONLY: Install the P-clamp (J) over the wiring on the driver's (left) side and attach to the upper bracket, with the "P" facing the frame (Fig. D.25). Attach the P clamp with one 1/4"-20 x 3/4" hex-head screw (N), two #12 flat washers (Q) and one 1/4" nylon lock nut (R). Tighten securely.

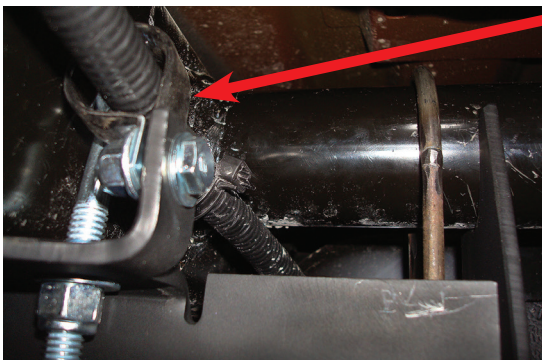

Reattach previously removed wiring onto the upper bracket on the driver's (left) side.

fig. D.25

NOTE

Perform steps 11-13 for gas model vehicles ONLY

11. FOR GAS MODELS ONLY: Install the P-clamp (J) around the wiring harness on the driver's (left) side (same as the last step). Then insert one 1/4"-20 x 3/4" bolt (N) into the EVAP control valve bracket (T) (Fig. D.26).

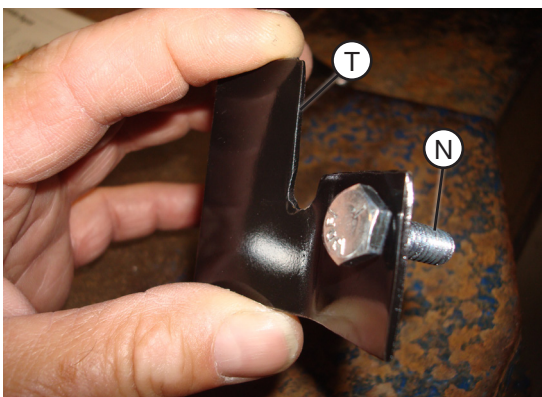

fig. D.26

12. Insert the bracket into the EVAP control valve using the same slot the stock bracket was removed from (Fig. D.27) then install the assembly onto the upper bracket as shown.



fig. D.27

13. Install the P-clamp previously put around the wiring, onto the EVAP control valve mounting bolt and attach with a #12 flat washer (Q) and 1/4" nylon lock nut (R) (Fig. D.28). If necessary, rotate or bend the bracket to gain as much clearance around the control valve as possible. Tighten securely.

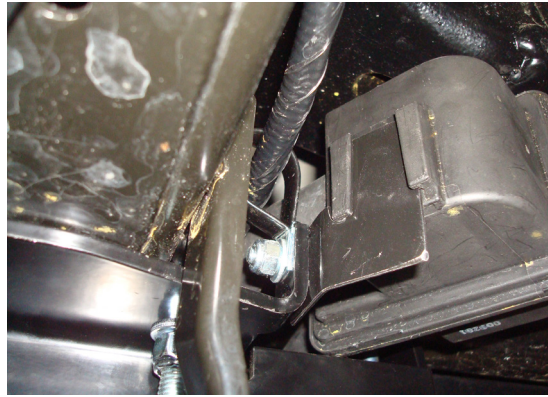
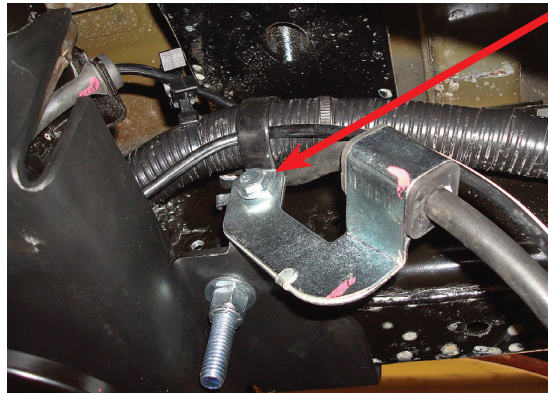

fig. D.28

14. Install the other P-clamp (J) around the passenger's (right) side wiring and ABS line that had been previously removed. Along with the previously removed axle vent tube bracket, attach the P-clamp and wiring to the upper bracket, using the same hardware specified from the driver's (left) side (Fig. D.29). Tighten securely.



Reattach the previously removed ABS line and axle vent tube bracket on the passenger's (right) side using a P-clamp.

fig. D.29

15. Bend the emergency brake line brackets, located on the axle, forward on both the driver's (left) and passenger's (right) side, forward of the axle, far enough for the line to gain clearance of the lower bracket (Fig. D.30).

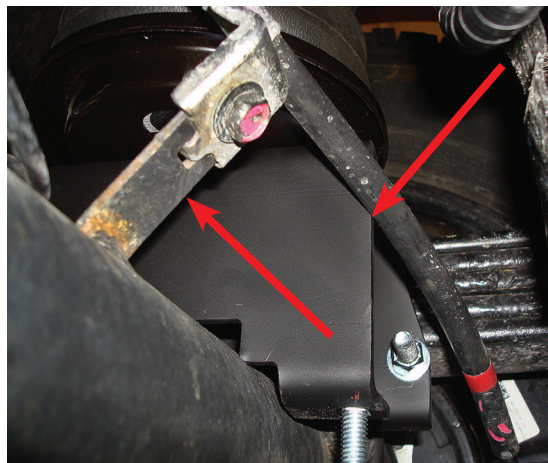

Bend the bracket slightly to gain clearance between the emergency brake line and lower bracket forward of the axle on both sides.

fig. D.30

16. Tie off the ABS line on the passenger's (right) side, which was disconnected from the axle bracket, to the axle vent tube with a zip tie (BB) (Fig. D.31).

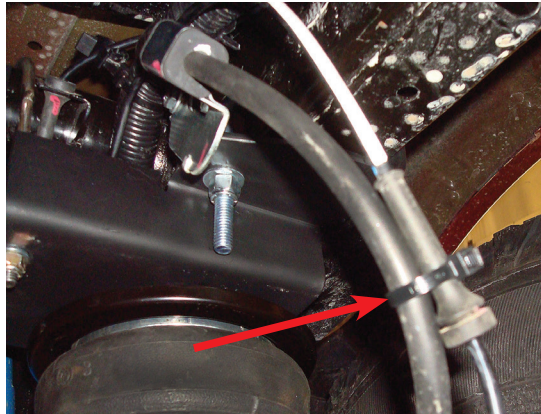

Zip tie the ABS line to the axle vent tube, as shown on the passenger's side.

fig. D.31

17. Tie off the ABS line behind the axle on the driver's (left) side to the soft brake line with a zip tie (BB) (Fig. D.32).

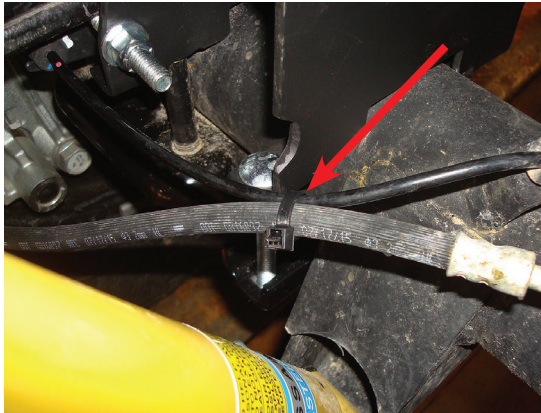

Zip tie the ABS line to the brake line as shown on the driver's (left) side.

fig. D.32

E. Installing the Air Lines

Air lines are routed from the air springs to Schrader valves. LoadLifter 5000 series air lines come in two styles: nylon and braided stainless steel. Begin by choosing locations for the Schrader valves and drill a 5/16" (8mm) hole, if necessary (Fig. E.1).

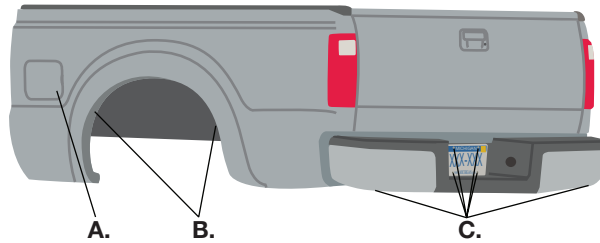

- A. Inside fuel tank filler door
- B. Inside rear wheel wells
- C. License plate or rear bumper area*

* For LoadLifter 5000 Ultimate Plus kits, the recommended location for the Schrader valves is the rear bumper area or license plate.

fig. E.1

CAUTION

KEEP AT LEAST 6" (150MM) OF CLEARANCE BETWEEN ALL AIR LINES AND THE EXHAUST SYSTEM. AVOID SHARP BENDS AND EDGES.

INSTALLING NYLON AIR LINES

1. Cut the air line in half. Make clean, square cuts with a razor blade or hose cutter (Fig. E.2). Do not use scissors or wire cutters.

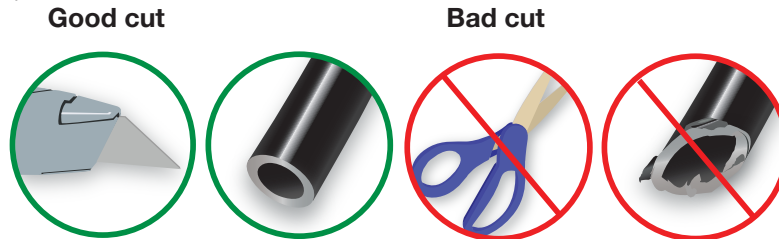

fig. E.2

2. Use zip ties to secure the air line to fixed points along the chassis. Do not pinch or kink the air line. The minimum bend radius for the air line is 1" (25mm). Leave at least 2" (50mm) of slack in the air line to allow for any movement that might pull on the air line.
3. Install the Schrader valve in the chosen location (Fig. E.3).

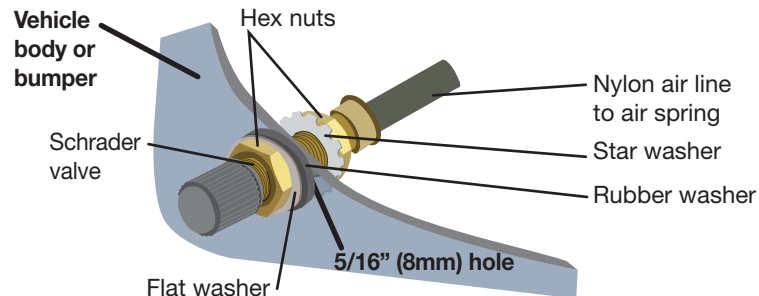

fig. E.3

F. Finished Installation

1. The following images show the finished installation of both sides (Figs. E.4, E.5 & E.6).



fig. E.4

Figure E.4 shows the rear view of the driver's (left) side installation.

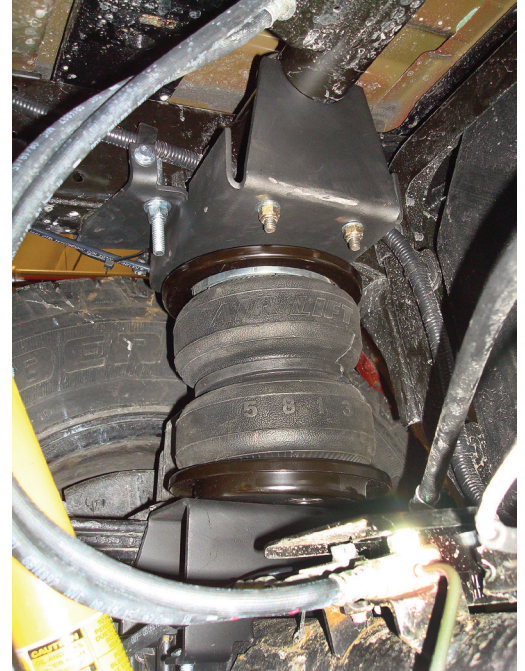

fig. E.5

Figure E.5 shows the inside rear view of the driver's (left) side installation.

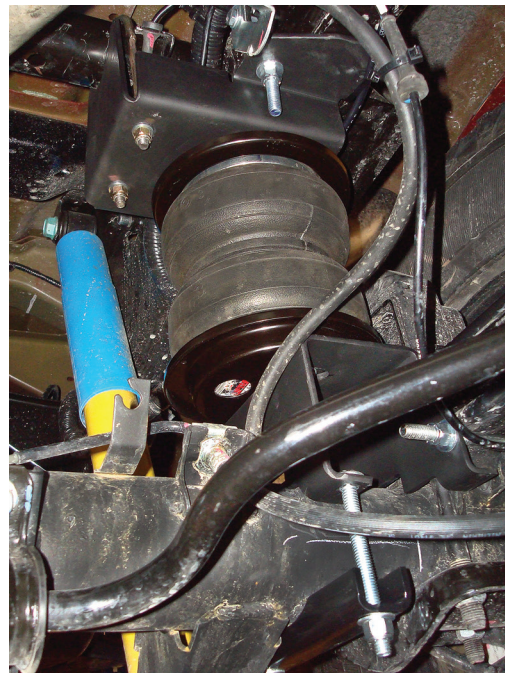

fig. E.6

Figure E.6 shows the passenger's (right) side rear view.

INSTALLATION CHECKLIST

- Clearance test** — Inflate the air springs to 40-60 PSI (2.8-4.1BAR) and make sure there is at least 1/2" (13mm) clearance from anything that might rub against each sleeve. Be sure to check the tire, brakes, frame, shock absorbers and brake cables.
- Leak test before road test** — Inflate the air springs to 40-60 PSI (2.8-4.1BAR) and check all connections for leaks. All leaks must be eliminated before the vehicle is road tested.
- Heat test** — Be sure there is sufficient clearance from heat sources, at least 6" (152mm) for air springs and air lines. If a heat shield was included in the kit, install it. If there is no heat shield, but one is required, call Air Lift customer service at **(800) 248-0892**.
- Fastener test** — Recheck all bolts for proper torque.
- Road test** — The vehicle should be road tested after the preceding tests. Inflate the air springs to recommended driving pressures. Drive the vehicle 10 miles (16km) and recheck for clearance, loose fasteners and air leaks.
- Operating instructions** — If professionally installed, the installer should review the operating instructions with the owner. Be sure to provide the owner with all of the paperwork that came with the kit.

G. Maintenance and Use Guidelines

1. Check air pressure weekly.
2. Always maintain normal ride height. Never inflate beyond 100 PSI (7BAR).
3. If the system develops an air leak, use a soapy water solution to check all air line connections and the inflation valve core before deflating and removing the air spring.

Minimum Recommended Pressure	Maximum Air Pressure
5 PSI (.34BAR)	100 PSI (7BAR)



FOR SAFETY AND TO PREVENT POSSIBLE DAMAGE TO THE VEHICLE, DO NOT EXCEED MAXIMUM GROSS VEHICLE WEIGHT RATING (GVWR) OR PAYLOAD RATING, AS INDICATED BY THE VEHICLE MANUFACTURER.



ALTHOUGH THE AIR SPRINGS ARE RATED AT A MAXIMUM INFLATION PRESSURE OF 100 PSI (7BAR), THE AIR PRESSURE ACTUALLY NEEDED IS DEPENDENT ON LOAD AND GROSS VEHICLE WEIGHT RATING.