

LoadLifter 5000™ ULTIMATE PLUS+



Installation Guide



2009-2014 Ford Raptor



Watch the video

Info on Table of Contents page

Kit 89412

For maximum effectiveness and safety, please read these instructions completely before proceeding with installation.

Failure to read these instructions can result in an incorrect installation.

TABLE OF CONTENTS

Installation Diagram	2
Hardware and Tools Lists	3
Introduction	4
Notation Explanation	4
Installing the System	5
Assembling the Air Springs	10
Installing the Assemblies	11
Installing the Air Lines	13
Installing Braided Stainless Steel Air Lines	13
Installing the Heat Shield	14
Finished Installation	15
Installation Checklist	16
Maintenance and Use Guidelines	16
Limited Warranty and Return Policy	16

Installation Diagram

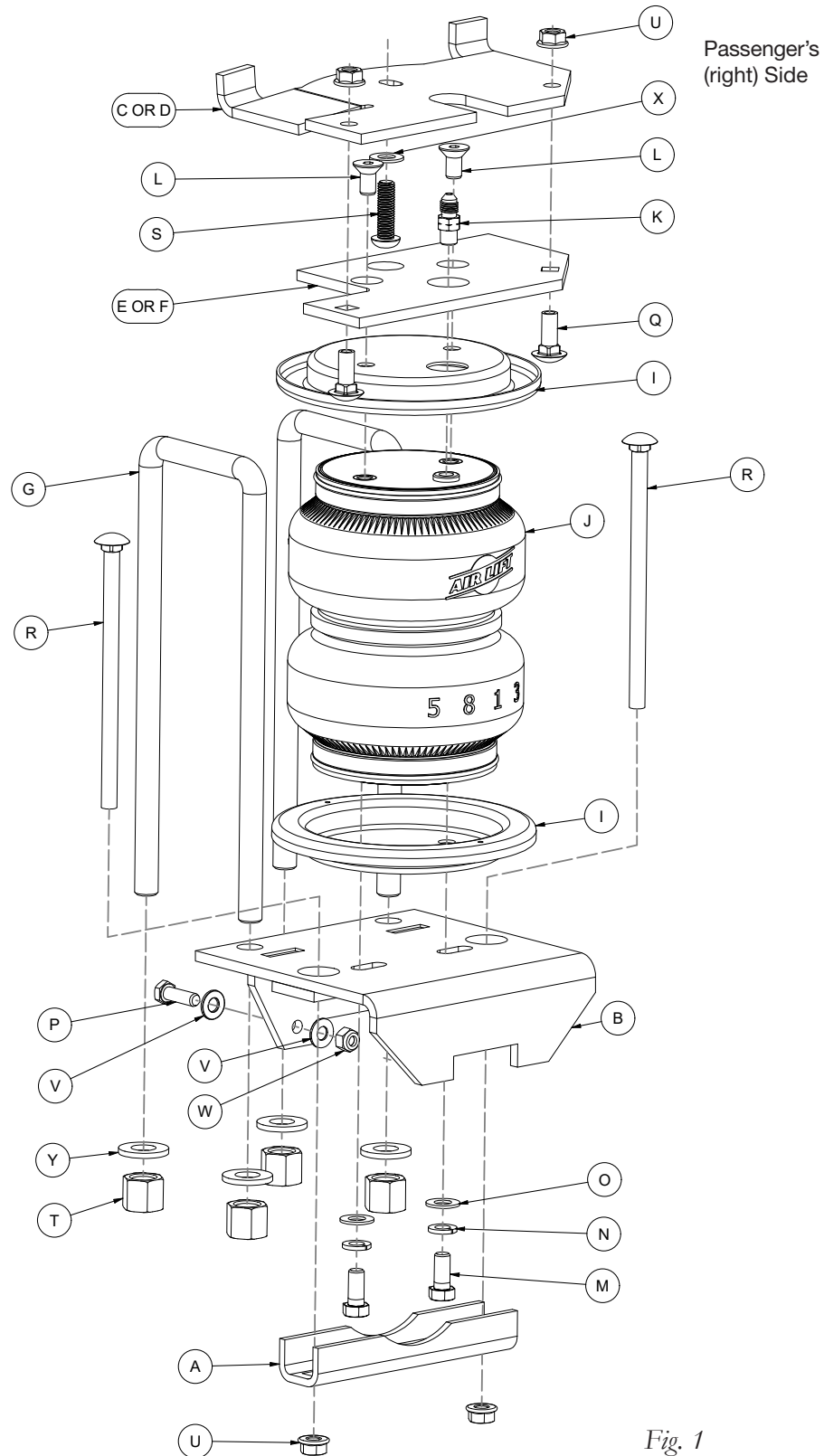

Hardware and Tools Lists

Included Parts

Item	Part#	Description	Qty
A	01531	Clamp bar	2
B	03875	Lower bracket	2
C	07079	LH upper frame bracket.....	1
D	07566	RH upper frame bracket	1
E	07788	RH upper spring bracket.....	1
F	07799	LH upper spring bracket.....	1
G	11686	U-bolt	4
H*	20987	Stainless steel braided air line	2
I	11880	Roll plate	4
J	58496	Air spring with jounce bumper	2
K	21804	AN type fitting	2
L	17363	3/8"-24 x 3/4" Flat-head socket cap screw	4
M	17284	3/8"-24 x 7/8" Hex cap screw.....	4
N	18504	3/8" Split lock washer.....	4
O	18507	3/8" Flat washer	4
P	17103	5/16"-18 x 1.0" Hex cap screw.....	1
Q	17134	3/8"-16 x 1.0" Carriage bolt.....	4
R	17490	3/8"-16 x 6.5" Carriage bolt.....	4
S	17366	M10 x 1.5 X 35 Button-head cap screw	2
T	18203	9/16"-18 Deep nut	8
U	18422	3/8"-16 Serrated flange lock nut.....	8
V	18433	5/16" Flat washer	2
W	18438	5/16"-18 Nylon lock nut.....	1
X	18444	3/8" Flat washer	2
Y	18635	9/16" Flat Washer	8
AA*	21813	AN to PTC fitting	2
BB*	10466	Zip ties	12
CC*	18501	M8 Flat washer.....	2
DD*	18411	5/16" Lock washer	2
EE*	21709	Schrader valve with cap & nut	2
FF*	21234	Rubber washer.....	2
GG*	20084	Air line assembly	1

* These parts are not shown in the Installation Diagram (Fig.1).

TOOLS LIST

Description.....	Qty
Hack saw or handheld grinder with a cut off wheel	1
Tire marker, crayon or paint.....	1
Standard and metric open-end or boxed wrenches	Set
Standard and metric regular and deep-well sockets	Set
Ratchet	1
9/16" Ratchet wrench.....	1
Torque wrench	1
Standard and metric hex-key wrench (socket preferable)	1
Hose cutter, razor blade, or sharp knife	1
Hoist and axle lift or floor jack.....	1
Tire chocks.....	2
Safety stands.....	3
Safety glasses	1
Air compressor or compressed air source	1
Spray bottle with dish soap/water solution.....	1
Small wire brush.....	1

Introduction

The purpose of this publication is to assist with the installation and maintenance of the LoadLifter 5000 Ultimate Plus air spring kits. All LoadLifter 5000 Ultimate Plus kits utilize sturdy, reinforced, commercial-grade single or double, depending on the kit, convolute bellows.

The air springs are manufactured like a tire with layers of rubber and cords that control growth. LoadLifter 5000 Ultimate Plus kits provide up to 5,000 pounds (2,268kg) of load-leveling support with air adjustability from 5-100 PSI (.34-7BAR).

It is important to read and understand the entire installation guide before beginning installation or performing any maintenance, service or repair.

NOTATION EXPLANATION

Hazard notations appear in various locations in this publication. Information which is highlighted by one of these notations must be observed to help minimize risk of personal injury or possible improper installation which may render the vehicle unsafe. Notes are used to help emphasize areas of procedural importance and provide helpful suggestions. The following definitions explain the use of these notations as they appear throughout this guide.



INDICATES IMMEDIATE HAZARDS WHICH WILL RESULT IN SEVERE PERSONAL INJURY OR DEATH.



INDICATES HAZARDS OR UNSAFE PRACTICES WHICH COULD RESULT IN SEVERE PERSONAL INJURY OR DEATH.



INDICATES HAZARDS OR UNSAFE PRACTICES WHICH COULD RESULT IN DAMAGE TO THE MACHINE OR MINOR PERSONAL INJURY.

Installing the System

CAUTION

IT WILL BE NECESSARY TO MOVE THE AXLE SPACER BLOCK/JOUNCE BUMPER STRIKE PLATE FROM ONE SIDE TO THE OTHER (FIG 3). THIS PROVIDES CLEARANCE FOR THE AIR SPRING ASSEMBLY, WHICH INSTALLS BETWEEN THE AXLE AND FRAME. CARE AND SAFETY MEASURES MUST BE TAKEN TO COMPLETE THIS TASK SAFELY AND SUCCESSFULLY.

1. With the vehicle on a hoist, block one tire in the front and rear with chocks then lift the frame slightly to take some pressure off the leaf springs (Fig. 2). Put a safety stand under the front of the differential to keep it from rotating.



Fig. 2

2. Mark the back side of each jounce bumper strike plate/axle spacer for ease of reinstallation (Fig. 3).

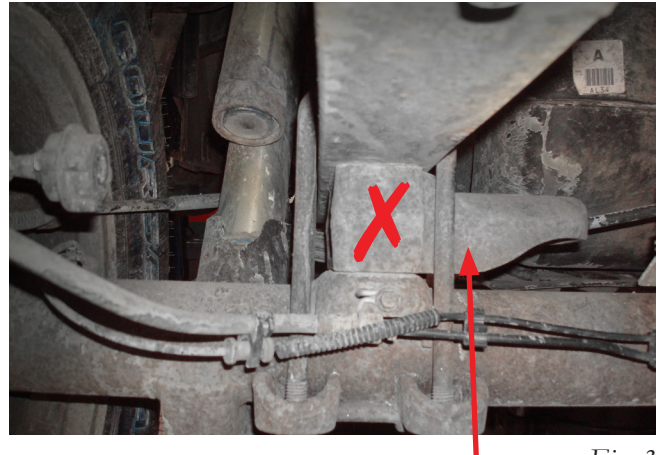

Fig. 3
Back view of driver's (left) side differential showing jounce bumper strike plate/spacer block with mark for reference as stated in step #2

⚠ CAUTION

DO NOT RUSH THROUGH THESE NEXT STEPS. USE ALL NECESSARY SAFETY PRECAUTIONS.

- Remove the stock U-bolts on both driver's (left) and passenger's (right) sides and discard. Lower the axle assembly or raise the frame up slowly, far enough to remove the jounce bumper strike plate/spacer blocks from between the leaf spring and axle. Move the driver's (left) side to the passenger's (right) side and the passenger's (right) to the driver's (left) side and install back between the leaf spring and axle (Fig. 4). Ensure that the mark on the back of the jounce bumper strike plate/axle spacer faces the rear. The strike plate should face the wheel, leaving the space between the frame and axle open. Drop the frame or raise the axle assembly slowly just far enough to hold the jounce bumper strike plate/spacer blocks into position.

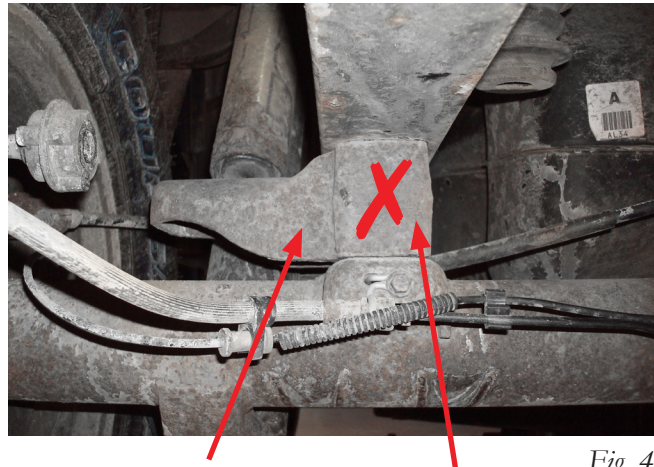

Fig. 4

Back view of driver's (left) side differential showing jounce bumper strike plate/spacer block with mark for reference as stated in step #2

NOTE

If the jounce bumper strike plate/spacer block is not positioned correctly, the pinion angle will be incorrect and may cause vibration while operating.

- Pull the jounce bumper out of the cup and unbolt the cup from the frame (Fig. 5).

TECH TIP

Using a wire brush, brush the rust off the bolt protruding through the weld nut on the frame. As much as possible, reach into the hole on the inside of the frame rail, above where the jounce bumper cup is bolted. Use penetrating fluid on these bolts before attempting to remove.



Fig. 5

- Remove the driver's (left) side ABS line off the ABS/brake line junction bolted to the axle (Fig. 6) and zip tie (BB) the ABS line to the axle vent tube.

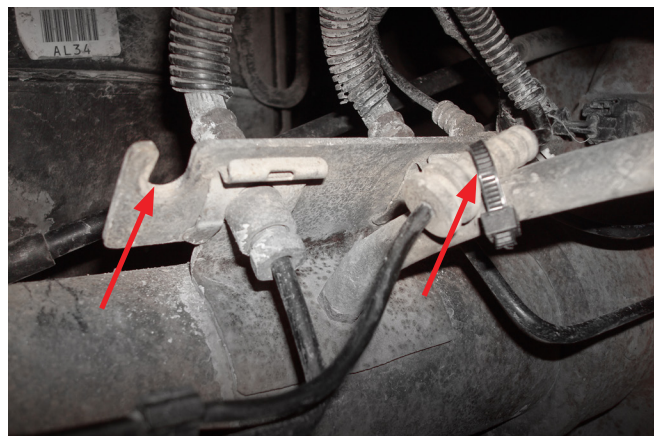

Fig. 6

6. Mark the location noted in Fig. 7 and cut the end of the bracket off using a hack saw or grinder with a cut off wheel. This will make room for the lower bracket.

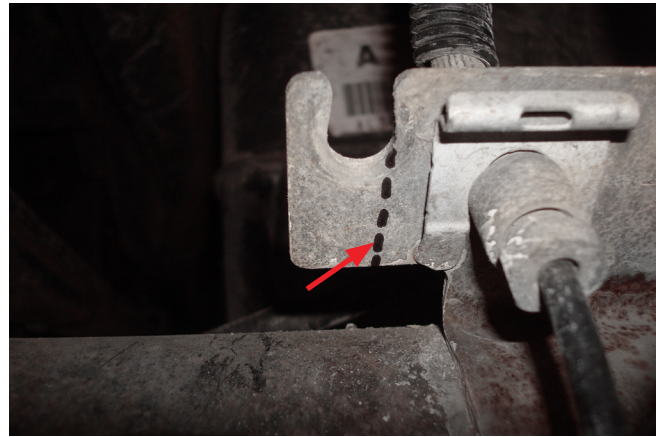

Fig. 7

7. Install a zip tie around the ABS/brake lines as shown in Fig. 8.

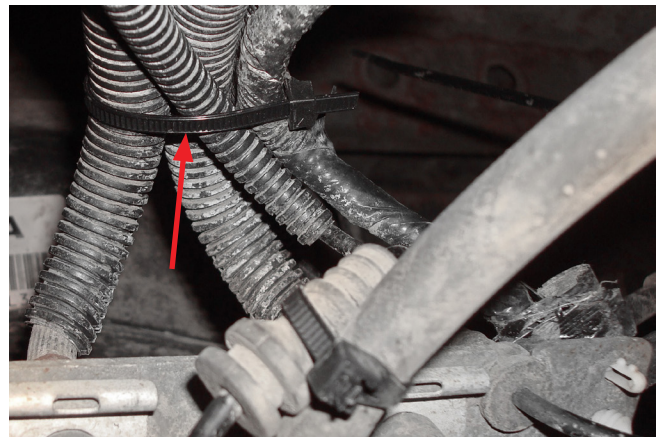
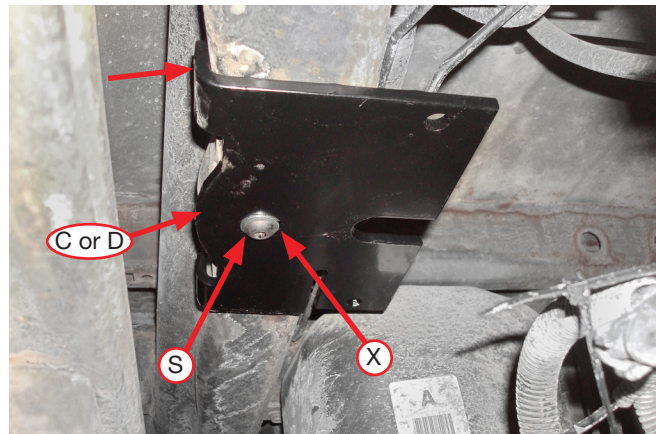

Fig. 8

8. Remove the emergency brake line bracket from the axle on the front, passenger's (right) side and discard the bolt. Let the bracket hang at this time.
9. Install the upper frame brackets (C & D) onto the frame using the M10 bolt (S) and flat washer (X) (Fig. 9). Push the brackets against the frame and torque the mounting hardware to 52Nm (38 lb.-ft.)



Driver's (left) side upper frame
bracket and hardware shown

Fig. 9

10. Set a lower bracket (B) onto the passenger's (right) side axle (Fig. 10) and insert the 5/16" hex cap screw (P) through a 5/16" flat washer (V) through the lower bracket, from the leaf spring side of the bracket, to the inside (toward the center of the vehicle). Push the bolt up against the bracket.

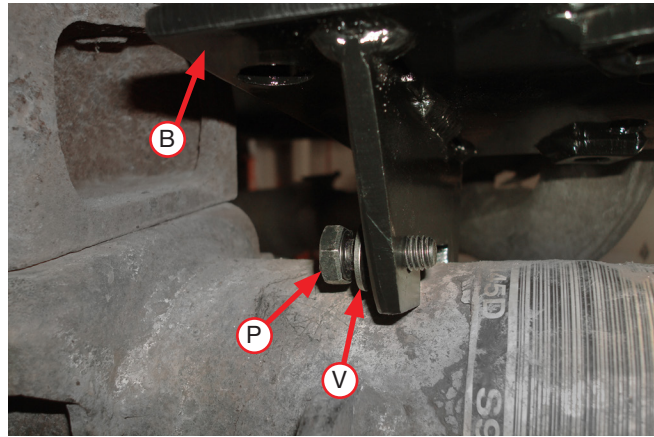
Fig. 10

11. Set the other lower bracket onto the driver's (left) side. Position both lower brackets so they are up against the leaf spring and jounce bumper strike plate/axle spacer assembly. Set the U-bolts (G) into position forward and rearward of the axle. Ensure inside legs of both U-bolts go through the holes in the lower bracket (Fig. 11).

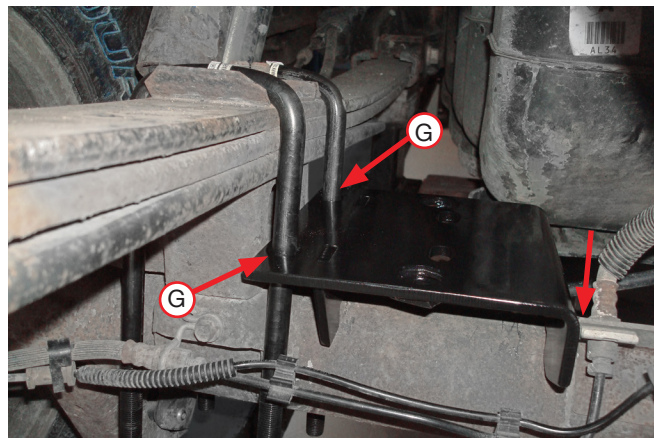
Fig. 11

NOTE

It may be necessary to trim the ABS/brake line bracket previously modified if the lower bracket does not fit into position without interference.

12. Once the lower brackets are in position and the U-bolts are in place, install the passenger's (right) emergency brake cable bracket onto the bolt previously installed (Fig. 12) making sure the "tab" on the bracket indexes in the space between the lower bracket and axle. Cap with a flat washer (V) and nylon lock nut (W). Leave loose at this time.

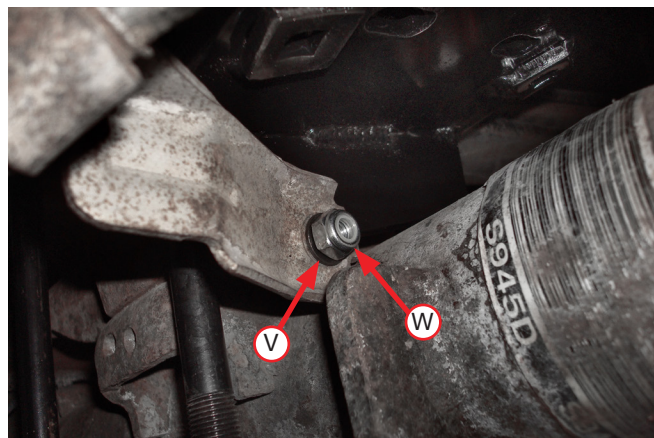
Fig. 12

13. Insert the carriage bolts (R) down through the holes in the upper bracket (Fig. 13), making sure the rear carriage bolts go between the hard brake lines and the axle (Fig. 14). Turn the heads of the carriage bolts so they index into the square holes in the bracket.

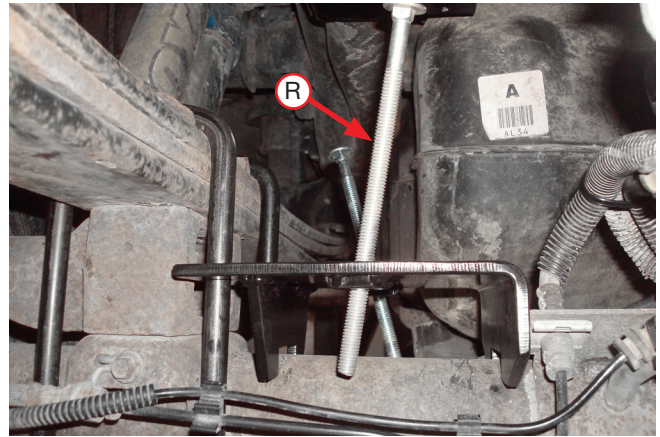

Fig. 13

14. Raise the axle assembly or lower the body all the way so that the leaf spring is supporting the vehicle. Set the lower axle/spring retainer over the U-bolts and cap with 9/16" flat washers (Y) and 9/16" deep nuts (T). Tighten finger-tight only at this time.

NOTE

Make sure the lower axle/spring retainer aligns with the wear marks on the axle before torquing U-bolts.

Install the lower clamp bar (A) over the carriage bolts previously installed and cap with 3/8" serrated flange lock nuts (U). Tighten finger-tight only at this time (Fig. 14).

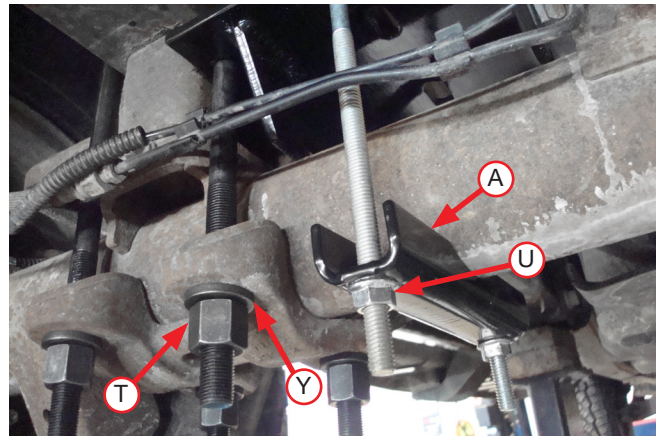

Fig. 14

15. In a criss-cross pattern, evenly torque the U-bolts to 90 lb.-ft. (122Nm). Once all the U-bolts have been torqued, torque the 3/8" lower bracket axle clamp hardware to 16 lb.-ft. (22Nm). On the passenger's (right) side, securely tighten the emergency brake cable bracket hardware previously installed.

NOTE

U-bolts must be retorqued after 100 miles.

ASSEMBLING THE AIR SPRINGS

1. Set a roll plate (I) onto the top of the air springs (J) and install the fittings (K) into the top of the air spring finger-tight. Tighten the fitting an additional 1 1/2 turns (Fig. 15).

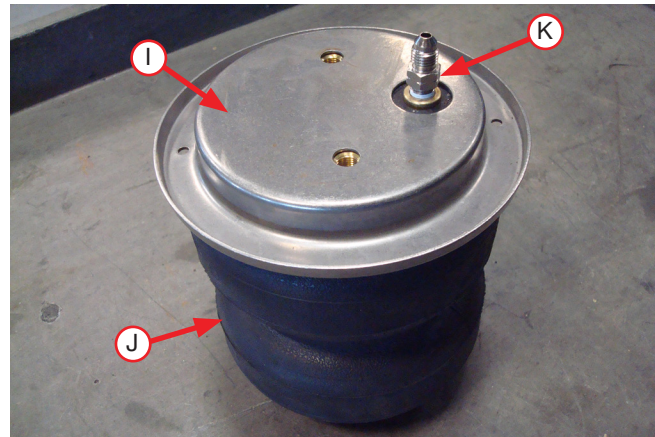

Fig. 15

2. Insert a 3/8" carriage bolt (Q) into the square hole of the right-hand upper spring bracket (E) on the opposite side of the tapered holes as shown in Fig. 16. Set the bracket onto the air spring assembly and install with two flat head screws (L). Torque the screws to no more than 20 lb.-ft. (27Nm). Install the braided hose (H) onto the fitting previously installed and turn one flat (see *Installing the Air Lines* section for reference).

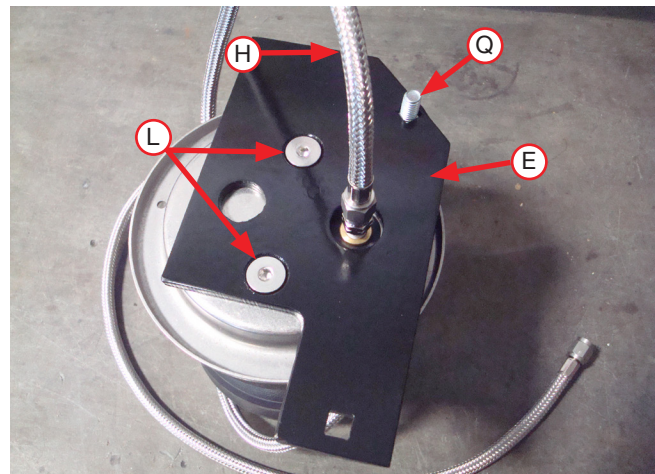

Fig. 16

3. Set the left-hand upper spring bracket (F) onto the remaining air spring and attach with two flat head screws (L). Install the braided hose (H) onto the fitting previously installed and turn one flat. Fig. 17 shows a picture of both left- and right-hand assemblies ready to be installed.



Fig. 17

INSTALLING THE ASSEMBLIES

1. Lower the axle assembly or raise the frame once again, just far enough so that the air spring assemblies can be put in place between the upper and lower bracket. While positioning the driver's (left) assembly into position above the axle, insert the hose in between the brake lines and wiring harness as shown in Fig. 18. Route the hose over the frame and to the back or side of the vehicle (see *Installing the Air Lines* section for reference). Do the same for the passenger's (right) side assembly.

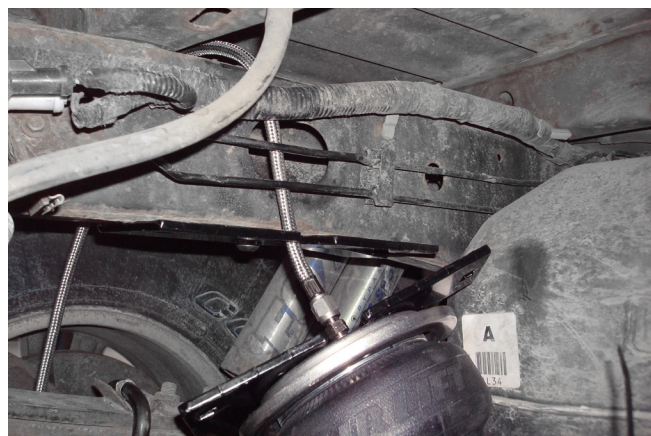

Fig. 18

2. While lifting up on the assemblies, insert two 3/8" carriage bolts (Q) up through the air spring bracket and frame bracket (Fig. 19).

NOTE

The passenger's (right) side already has one of the 3/8" carriage bolts installed.

Cap with the 3/8" serrated flange lock nuts (U).
Torque hardware on both sides to 31 lb.-ft. (42Nm).

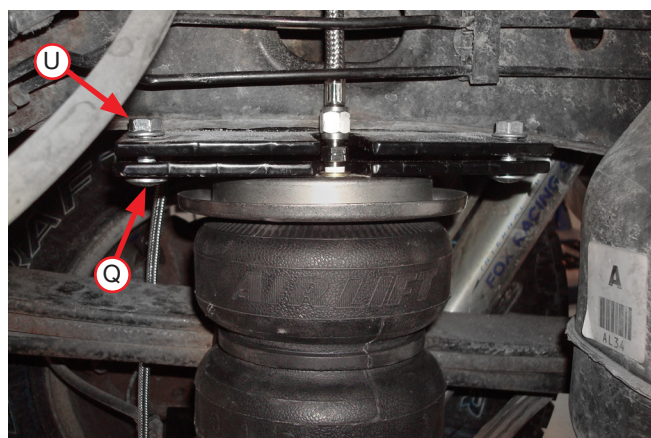

Fig. 19

3. Set a roll plate (I) onto the lower bracket below the air spring assembly (Fig. 20). Align the holes in the air spring/roll plate/lower bracket as much as possible. Raise the axle assembly up or lower the frame just far enough so that the air spring sits on the lower bracket (Fig. 21).

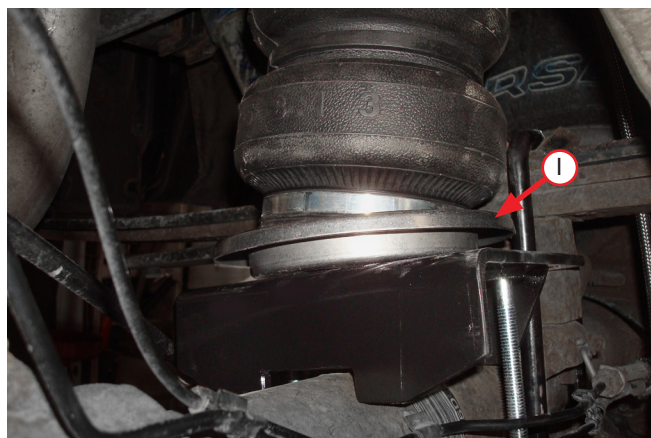

Fig. 20



Fig. 21

4. Insert a 3/8" hex cap screw (M) through a split lock washer (N) and flat washer (O) then attach the air spring to the lower bracket by inserting the assembly up through the slot in the lower bracket (Fig. 22). Push the air spring so that the hardware is to the back of the slot and tighten the hardware securely.

TECH TIP

A 9/16" ratchet wrench works well in tightening this hardware.

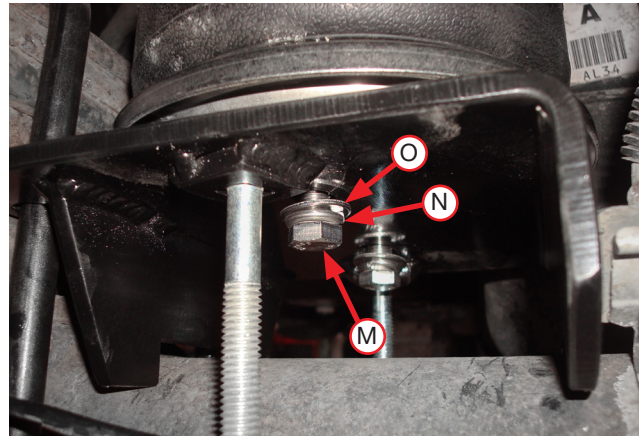

Fig. 22

5. Raise the axle assembly or lower the frame of the vehicle. Remove the safety stands and wheel chocks. On the inside frame of the driver's (left) side above the air spring assembly, make sure that the brake lines and wiring harness are not rubbing on the steel braided air line (Fig. 23). If they are, carefully bend the brake line away from the air line to obtain clearance. For the wiring harness, it may be necessary to pry the line holder out of the frame and pull away from the air line to obtain enough clearance.

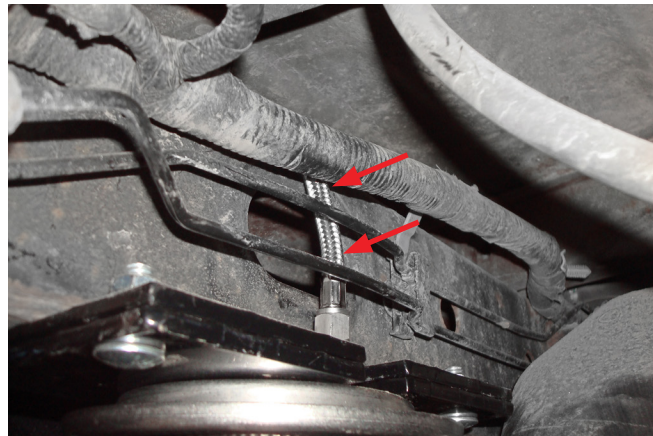

Fig. 23

6. Do the same for the brake lines behind the axle, make sure there is enough clearance between the carriage bolt and the brake line. Pull the line away if it is hitting on the carriage bolt (Fig. 24).

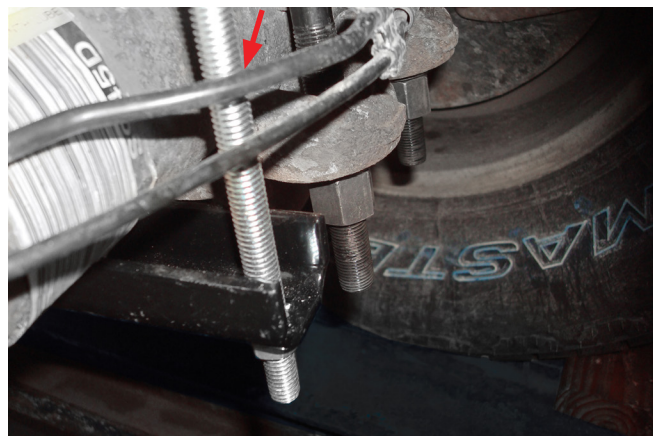

Fig. 24

Installing the Air Lines

INSTALLING BRAIDED STAINLESS STEEL AIR LINES

CAUTION

KEEP THE AIR LINE AWAY FROM THE FUEL LINE, BRAKE LINES AND ELECTRICAL WIRES.

NOTE

The braided stainless steel air line must be routed to the rear of the vehicle. Install the air line through one of the openings between the upper coil spring mount and the frame and then back to the rear where the inflation valves will be mounted (Fig. 25).

1. Use zip ties to secure the air line to fixed points along the chassis every 6" to 8" (150-200mm). Leave at least 2" (50mm) of slack to allow for any movement that might pull on the air line.

2. Tighten the air line hex nut finger-tight, then use 2 wrenches to turn 1 additional flat (1/6 of one full turn). Do not overtighten (Fig. 26 & Fig. 27). The easiest way to tighten the fitting is off the vehicle. Install the Schrader valve in the chosen location.
3. Coil and secure any excess air line in an area where it will not be susceptible to damage. The braided stainless steel air line cannot be trimmed.

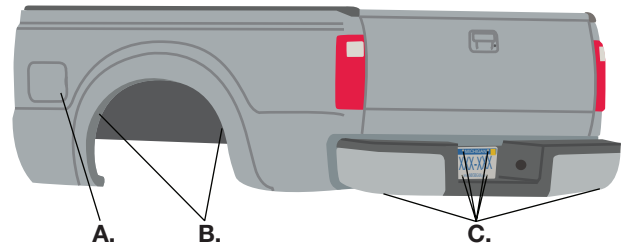

* For LoadLifter 5000 Ultimate Plus kits, the recommended location for the Schrader valves is the rear bumper area or license plate.

- A. Inside fuel tank filler door B. Inside rear wheel wells C. License plate or rear bumper area*

Fig. 25

Air Line Setup Without Compressor System

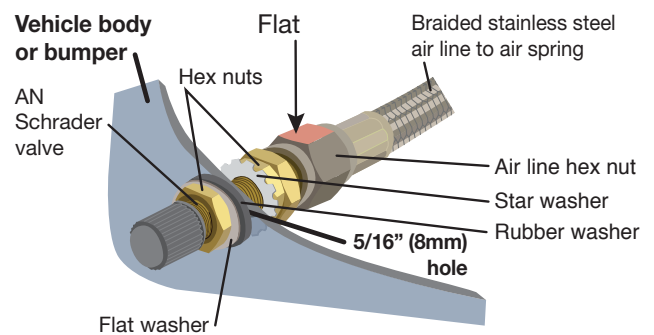

Fig. 26

Air Line Setup for Compressor Integration

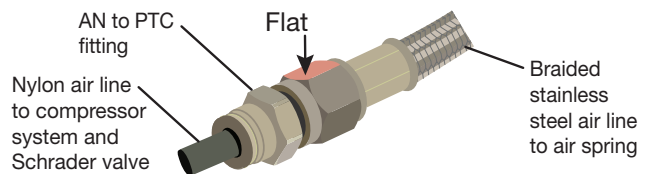

Fig. 27

INSTALLING THE HEAT SHIELD

1. Install the heat shield above the air spring assembly on the inside pipe as shown in Fig. 28.

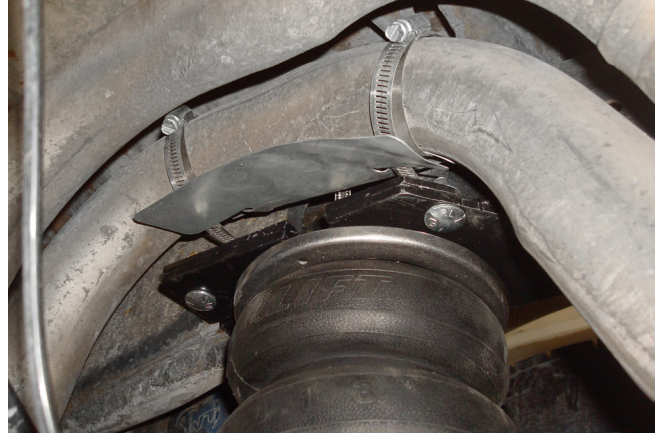

Fig. 28

2. Bend the heat shield up so that it is between the pipe and the air line (Fig. 29 & Fig. 30).

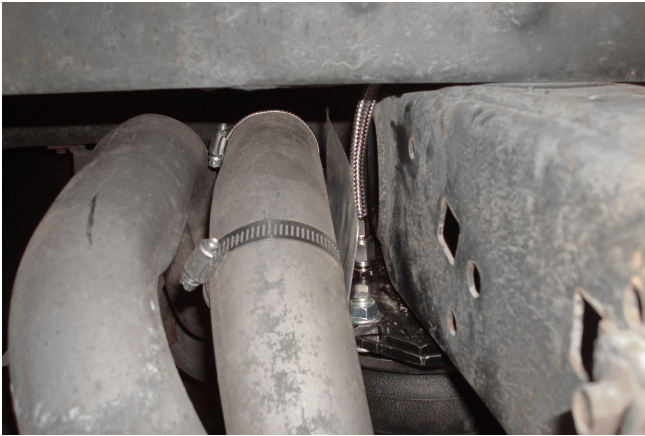

Fig. 29

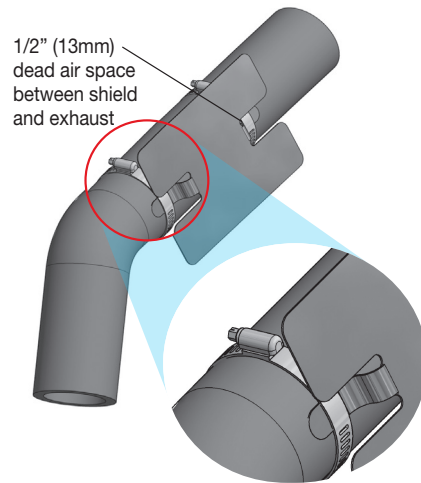
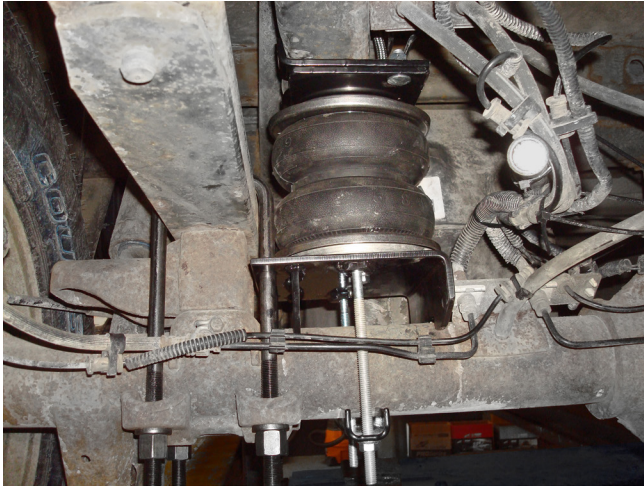

Fig. 30

Finished Installation

The images show the finished installation of both sides (Fig. 31 - Fig. 34).



Driver's (left) side behind the axle view.

Fig. 31



Driver's (left) side inside above the axle assembly view.

Fig. 32



Passenger's (right) forward axle view.

Fig. 33



Passenger's (right) inside above the axle view.

Fig. 34

INSTALLATION CHECKLIST

- Clearance test** — Inflate the air springs to 40-60 PSI (2.8-4.1BAR) and make sure there is at least 1/2" (13mm) clearance from anything that might rub against each sleeve. Be sure to check the tire, brakes, frame, shock absorbers and brake cables.
- Leak test before road test** — Inflate the air springs to 40-60 PSI (2.8-4.1BAR) and check all connections for leaks. All leaks must be eliminated before the vehicle is road tested.
- Heat test** — Be sure there is sufficient clearance from heat sources, at least 6" (152mm) for air springs and air lines. If a heat shield was included in the kit, install it. If there is no heat shield, but one is required, call Air Lift customer service at (800) 248-0892.
- U-bolt** - After 100 miles (161km), retorque U-bolts.
- Fastener test** — After 500 miles (800km), recheck all bolts for proper torque.
- Road test** — The vehicle should be road tested after the preceding tests. Inflate the air springs to recommended driving pressures. Drive the vehicle 10 miles (16km) and recheck for clearance, loose fasteners and air leaks.
- Operating instructions** — If professionally installed, the installer should review the operating instructions with the owner. Be sure to provide the owner with all of the paperwork that came with the kit.

MAINTENANCE AND USE GUIDELINES

1. Check air pressure weekly.
2. Always maintain normal ride height. Never inflate beyond 100 PSI (7BAR).
3. If the system develops an air leak, use a soapy water solution to check all air line connections and the inflation valve core before deflating and removing the air spring.

Minimum Recommended Pressure
5 PSI (.34BAR)

Maximum Air Pressure
100 PSI (7BAR)

CAUTION

FOR SAFETY AND TO PREVENT POSSIBLE DAMAGE TO THE VEHICLE, DO NOT EXCEED MAXIMUM GROSS VEHICLE WEIGHT RATING (GVWR) OR PAYLOAD RATING, AS INDICATED BY THE VEHICLE MANUFACTURER. ALTHOUGH THE AIR SPRINGS ARE RATED AT A MAXIMUM INFLATION PRESSURE OF 100 PSI (7BAR), THE AIR PRESSURE ACTUALLY NEEDED IS DEPENDENT ON LOAD AND GROSS VEHICLE WEIGHT RATING.