

LoadLifter 5000™ ULTIMATE PLUS+



Installation Guide



Ford Raptor



Watch the video

Info on Table of Contents page

Kit 89413

For maximum effectiveness and safety, please read these instructions completely before proceeding with installation.

Failure to read these instructions can result in an incorrect installation.

TABLE OF CONTENTS

Installation Diagram	2
Hardware and Tools Lists	3
Introduction	4
Notation Explanation	4
Installing the System	5
Getting Started	5
Option #1	6
Option #2	6
Getting Started Continued	8
Assembling the Air Springs	16
Installing the Assemblies	17
Installing the Air Lines	19
Installing Braided Stainless Steel Air Lines	19
Finished Installation	20
Installation Checklist	21
Maintenance and Use Guidelines	21

Installation Diagram

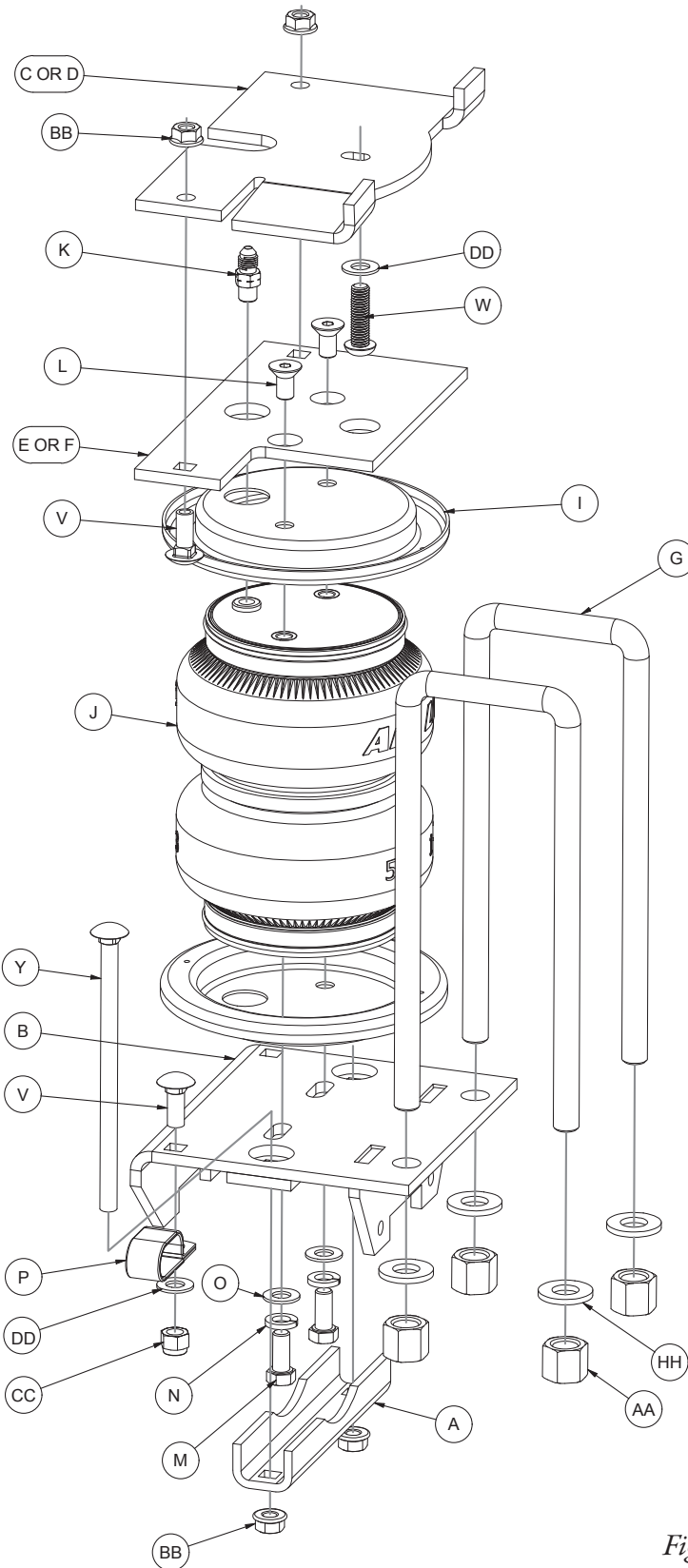

Driver's
(left) side

Fig. 1

Hardware and Tools Lists

HARDWARE LIST

Item	Part#	Description	Qty
A	01531	Clamp bar	2
B	03875	Lower bracket	2
C	07079	LH upper frame bracket.....	1
D	07566	RH upper frame bracket	1
E	07788	RH upper spring bracket.....	1
F	07799	LH upper spring bracket.....	1
G	11676	U-bolt	4
H*	20987	Stainless steel braided air line	2
I	11880	Roll plate.....	4
J	58496	Air spring with jounce bumper.....	2
K	21804	AN type fitting	2
L	17363	3/8"-24 X 3/4" Flat-head socket cap screw.....	4
M	17284	3/8"-24 X 7/8" Hex cap screw	4
N	18504	3/8" Split lock washer.....	4
O	18507	3/8" Flat washer	4
P	10181	Oval P clamp.....	1
Q*	10868	Tree mount fitting	2
R*	11180	ABS spacer bracket.....	2
S*	11181	#56 Clamp.....	2
T*	11185	Parking brake cable bracket adapter.....	1
U*	13964	Spacer.....	2
V	17134	3/8"-16 X 1" Carriage bolt.....	5
W	17366	M10-1.50 X 35 Button-head cap screw.....	2
X*	17380	M8-1.25 X 40 Hex-head cap screw	2
Y	17490	3/8"-16 X 6 1/2" Carriage bolt	4
Z*	17496	M8-1.25 X 20 Hex-head cap screw	2
AA	18203	9/16"-18 Deep nut	8
BB	18422	3/8"-16 Serrated flange lock nut.....	8
CC	18435	3/8"-16 Nylon lock nut.....	1
DD	18444	3/8" Flat washer	3
EE*	18501	M8 Flat washer.....	4
FF*	18503	M8 Split lock washer.....	3
GG*	18522	M8-1.25 Nylon lock nut.....	1
HH	18635	9/16" U-bolt flat washer.....	8
II*	21813	AN to PTC fitting	2
JJ*	10466	Zip ties	12
LL*	18501	M8 Flat washer.....	2
MM*	18411	5/16" Lock washer	2
NN*	21709	Schrader valve with cap & nut	2
OO*	21234	Rubber washer.....	2
PP*	20084	Air line assembly	1

* These parts are not shown in the Installation Diagram (Fig. 1).

TOOLS LIST

Description.....	Qty
Hack saw or handheld grinder with a cut off wheel	1
Tire marker, crayon or paint.....	1
Standard and metric open-end or boxed wrenches	Set
Standard and metric regular and deep-well sockets	Set
Ratchet	1
9/16" Ratchet wrench.....	1
Torque wrench.....	1
Standard and metric hex-key wrench (socket preferable)	1
Hose cutter, razor blade, or sharp knife	1
Hoist and axle lift or floor jack.....	1
Tire chocks.....	2
Safety stands.....	2
Safety glasses	1
Air compressor or compressed air source.....	1
Spray bottle with dish soap/water solution.....	1
Grinder with grinding wheel	1

Introduction

The purpose of this publication is to assist with the installation and maintenance of the LoadLifter 5000 Ultimate Plus air spring kits. All LoadLifter 5000 Ultimate Plus kits utilize sturdy, reinforced, commercial-grade single or double, depending on the kit, convolute bellows.

The air springs are manufactured like a tire with layers of rubber and cords that control growth. LoadLifter 5000 Ultimate Plus kits provide up to 5,000 pounds (2,268kg) of load-leveling support with air adjustability from 5-100 PSI (.34-7BAR).

It is important to read and understand the entire installation guide before beginning installation or performing any maintenance, service or repair.

NOTATION EXPLANATION

Hazard notations appear in various locations in this publication. Information which is highlighted by one of these notations must be observed to help minimize risk of personal injury or possible improper installation which may render the vehicle unsafe. Notes are used to help emphasize areas of procedural importance and provide helpful suggestions. The following definitions explain the use of these notations as they appear throughout this guide.

**DANGER**

INDICATES IMMEDIATE HAZARDS WHICH WILL RESULT IN SEVERE PERSONAL INJURY OR DEATH.

**WARNING**

INDICATES HAZARDS OR UNSAFE PRACTICES WHICH COULD RESULT IN SEVERE PERSONAL INJURY OR DEATH.

**CAUTION**

INDICATES HAZARDS OR UNSAFE PRACTICES WHICH COULD RESULT IN DAMAGE TO THE MACHINE OR MINOR PERSONAL INJURY.

Installing the System

GETTING STARTED

CAUTION

IT WILL BE NECESSARY TO MOVE THE AXLE SPACER BLOCK/JOUNCE BUMPER STRIKE PLATE FROM ONE SIDE TO THE OTHER (FIG. 3) TO GAIN CLEARANCE FOR THE AIR SPRING ASSEMBLY WHICH INSTALLS BETWEEN THE AXLE AND FRAME. IN DOING SO, CARE AND SAFETY MEASURES MUST BE TAKEN TO COMPLETE THIS TASK SAFELY AND SUCCESSFULLY.

1. With the vehicle on a hoist, block one tire in the front and rear with chocks then lift the frame slightly to take pressure off the leaf springs (Fig. 2). Put a safety stand under the front of the differential to keep it from rotating when dropping the axle assembly down.
2. Mark the back side of each jounce bumper strike plate/axle spacer with a tire marker, crayon or paint for correct reinstallation (Fig. 3).

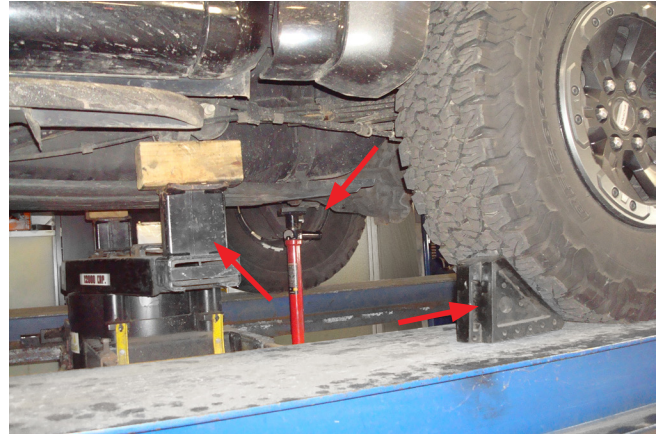
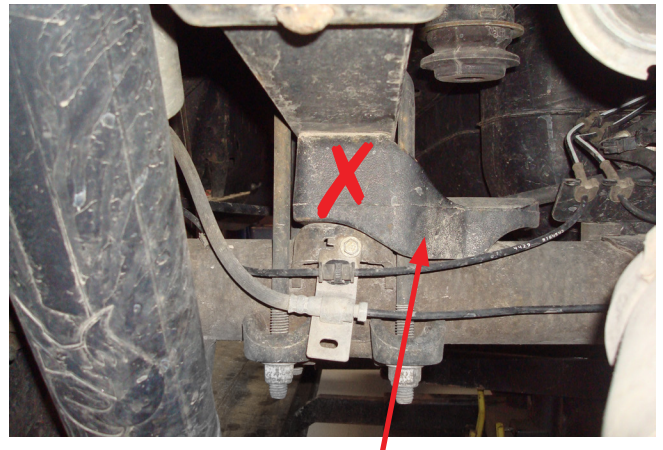

Fig. 2



Back view of driver's (left) side differential showing jounce bumper strike plate/spacer block with mark for reference as stated in Step 2.

Fig. 3

CAUTION

DO NOT RUSH THROUGH THE NEXT STEPS. PAY ATTENTION AND FOLLOW SAFETY CAUTIONS TO ENSURE SAFE AND CORRECT INSTALLATION.

3. Remove the stock U-bolts on both driver's (left) and passenger's (right) sides and discard. Lower the axle assembly or raise the frame up slowly, far enough to remove the jounce bumper strike plate/spacer blocks from between the leaf spring and axle.

4. Remove both ABS line tree holders from the small brackets welded to the axle on the outside of the leaf spring assemblies (Fig. 4).

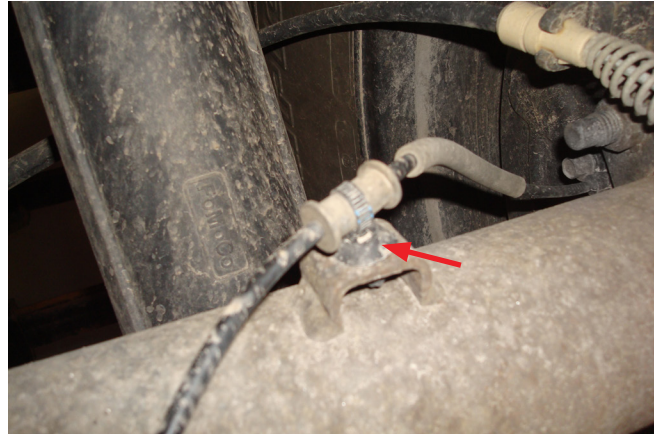

Fig. 4

Modifications will need to be made at this point before the strike plate/spacer blocks can be put into position. There are two options:

OPTION #1

Cut the bracket that held the ABS tree mount, shown in figure 4, off the axle using a grinder and cut off wheel.

OPTION #2

The following steps apply to Option #2. If following Option #1, proceed to Step 7 on page 8.

5. Swap the driver's (left) side jounce bumper strike plate/axle spacer and the passenger's (right) side jounce bumper strike plate/axle spacer and install back between the leaf spring and axle. Ensure the mark on the back of the jounce bumper strike plate/axle spacer faces the rear. The strike plate should be facing the wheel now leaving the space between the frame and axle open.

6. Using the tire marker crayon or paint, mark the underside of the strike plate where the ABS line bracket that is welded to the axle, contacts it (Fig. 5). Mark the underside of the strike plate in the front and the rear of the axle. Remove one at a time and using a grinder, remove a 1/4" of material off the strike block to gain clearance between the ABS bracket and strike plate (Fig. 6). Set back into position and check clearance. If the spacer block/strike plate does not fit flat on the spring perch, remove more material in between the lines marked until it sits flat with no interference from the bracket (Fig. 7).

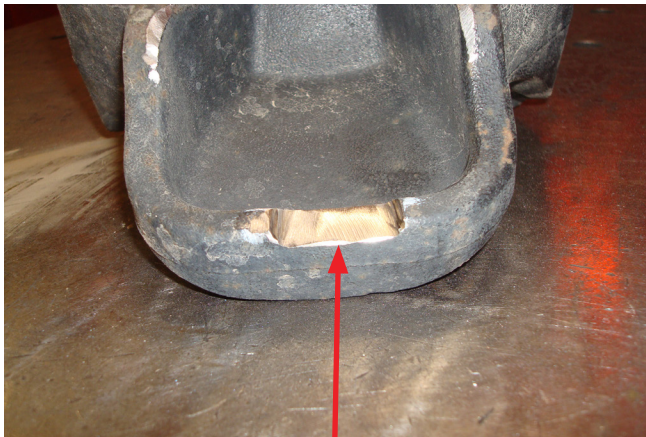
*Fig. 5*

Grind out area between marks made from ABS bracket as shown.

Fig. 6

Grind strike plate so that there is clearance between the ABS bracket and strike plate when spacer is sitting on the spring perch.

Fig. 7

GETTING STARTED CONTINUED

- Using proper safety precautions, drop the frame or raise the axle assembly slowly, just far enough to hold the jounce bumper strike plate/axle spacer blocks into position.

NOTE

If the jounce bumper strike plate/axle spacer block is not positioned correctly, the pinion angle will not be correct and may induce vibration when operating. Ensure the marks on the spacer blocks are facing the rear of the vehicle.

- Unbolt the jounce bumper and cup from the frame and discard (Fig. 8 & Fig. 9).

TECH TIP

Using a wire brush, reach into the hole on the inside of the frame rail, above where the jounce bumper cup is bolted, brush the rust off the bolt that is protruding through the weld nut on the frame. Spray penetrating fluid on these bolts before attempting to remove.



Fig. 8



Jounce bumper and cup removed.

Fig. 9

9. Behind the axle on the passenger's (right) side in between the differential and leaf spring there is a bracket holding the brake line/ABS line. Pull the tree mount holding the ABS line out of the bracket and reposition the tree mount so it is behind the bracket, not on top of it. Zip tie (JJ) the tree mount onto the brake line as shown (Fig. 10 & Fig. 11).

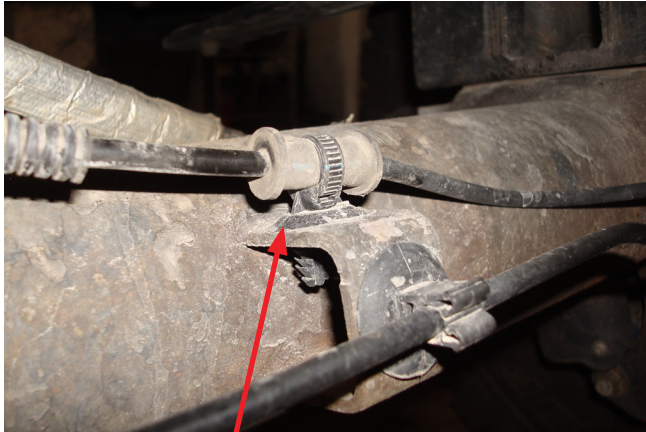

Pull the tree mount holding the ABS line, out of the top mounting of the bracket. *Fig. 10*



Use a zip tie and attach ABS line to brake line as shown. *Fig. 11*

10. It will be necessary to modify the bracket that holds the ABS brake line and vent tube, located on the driver's (left) side axle (Fig. 12). Remove both the right and left ABS lines from their slots in the bracket. Then remove the left line from the line holder (Fig. 13). Move the ABS lines inboard as far as possible to gain access to the bracket.

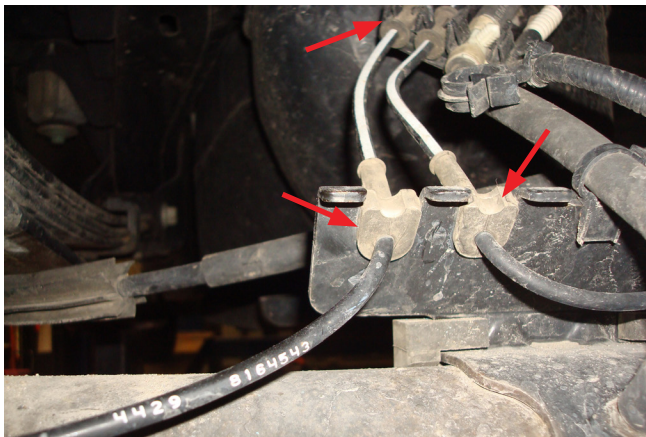
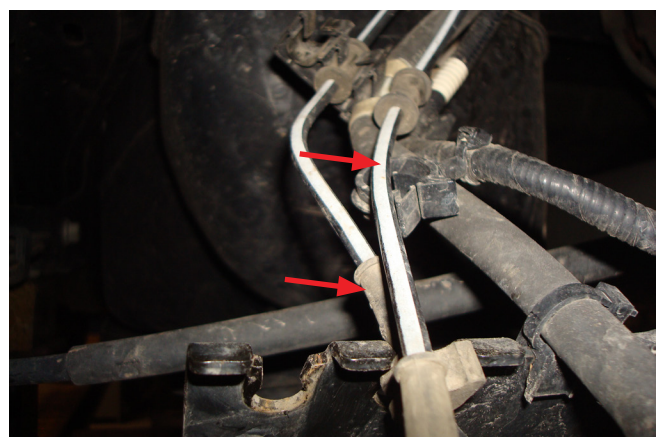

Fig. 12



Pull the ABS lines out and away from the left side of the bracket bolted to the axle. *Fig. 13*

11. Using a tire marker, crayon or paint, mark the bracket just outside the second ABS slot as shown (Fig. 14). Be sure to mark it so it leaves enough material that the inside ABS slot can be reused.



Fig. 14

12. Using a hack saw or grinder with a cut off wheel, trim the bracket so that the outside ABS slot is removed (Fig. 15). Smooth the edges so the end cut is not sharp.

⚠ CAUTION

USE PROPER CAUTION AND SAFETY EQUIPMENT WHEN USING HACK SAW OR GRINDER.



Fig. 15

13. Finish by reattaching the inside ABS line and securing the outside ABS line with zip ties (JJ) as shown (Fig. 16).



Fig. 16

14. Space the brake line brackets out from behind the axle by removing the stock bolt. Pull the bracket away from the axle and insert a spacer (U) between the bracket and axle. Attach with the M8 hex-head cap screw (X) split lock washer (FF) and flat washer (EE) (Fig. 17). Tighten securely and repeat for opposite side.

⚠ CAUTION

SOME MINOR BENDING OF THE HARD BRAKE LINE MAY BE NECESSARY TO GAIN CLEARANCE ON AXLE OR ANY OTHER COMPONENT WHICH MAY NOW COME IN CONTACT WITH IT FROM SPACING THE BRACKET.

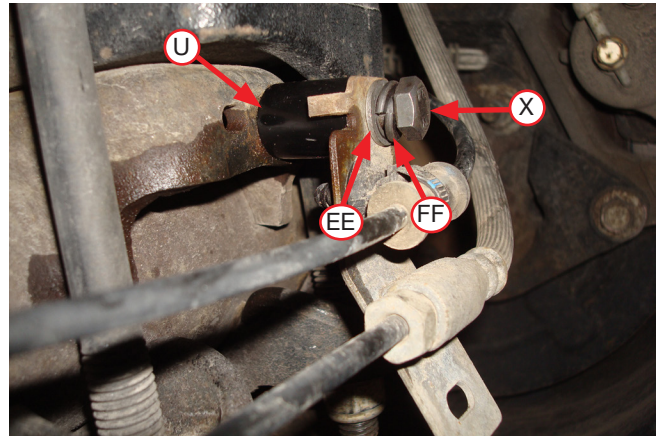

Fig. 17

15. Reattach the ABS lines that were removed in step 4 by attaching the ABS spacer brackets (R) to the axle with the #56 clamp (S). Attach so that the top of the bracket with the hole is right under the ABS line as show (Fig. 18).

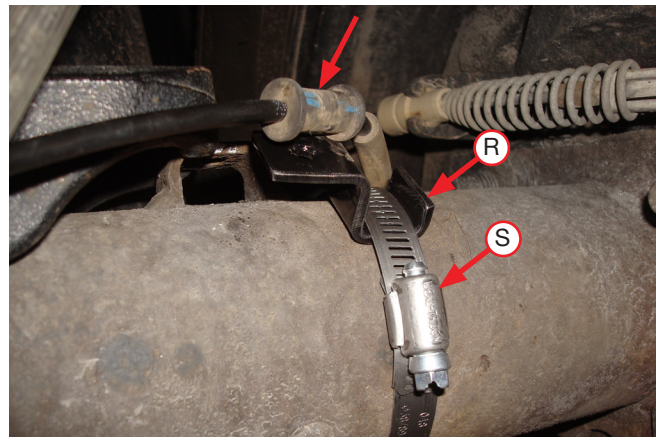

Fig. 18

16. Install the supplied tree mount fitting (Q) into the top of the ABS bracket (Fig. 19).



Fig. 19

17. Secure the ABS line to the tree mount fitting with a zip tie (JJ) (Fig. 20). Repeat for the opposite side.

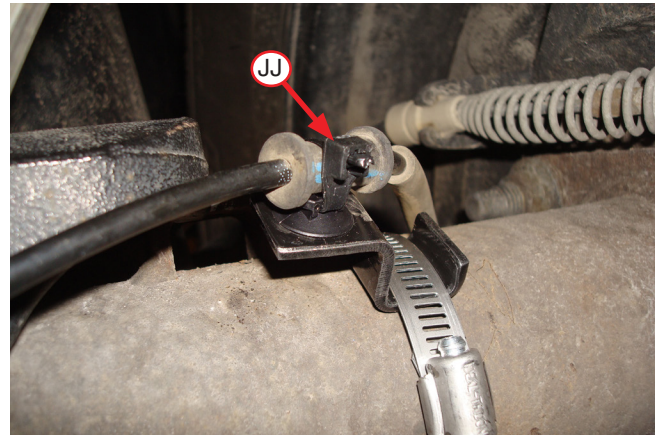

Fig. 20

18. Remove the bolt holding the parking brake cable bracket to the spring perch that is mounted on the passenger's (right) side, forward of the axle and discard the bolt (Fig. 21).



Fig. 21

19. Attach the parking brake cable bracket to the parking brake cable bracket adapter (T) with M8 hex cap screw (Z) two flat washers (EE) and nylon lock nut (GG) (Fig. 22). Leave loose at this time.

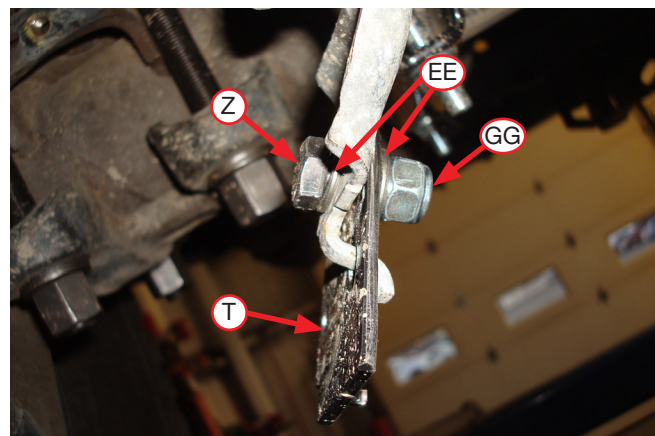

Fig. 22

20. Attach the parking brake cable bracket on the spring perch where the bracket was previously attached using an M8 hex head cap screw (Z) and lock washer (FF) making sure the tab on the bracket is indexed in the spring perch hole properly (Fig. 23). Tighten all hardware securely.

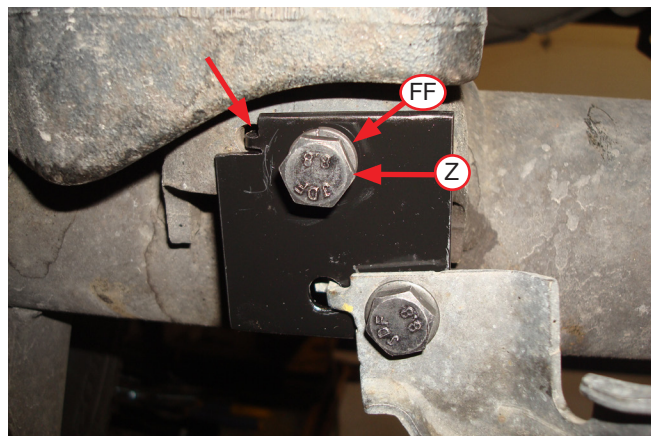
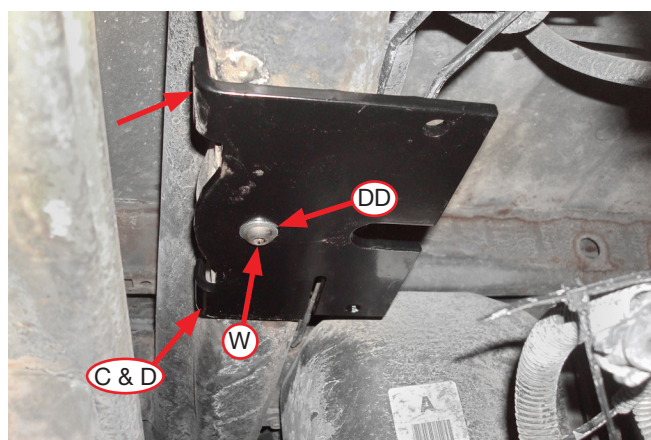

Fig. 23

21. Install the upper frame brackets (C & D) onto the frame using the M10 bolt (W) and flat washer (DD) (Fig. 24). Push the brackets against the frame and torque the mounting hardware to 38 lb.-ft. (52Nm)



Driver's (left) side upper frame bracket and hardware shown.

Fig. 24

22. Set the lower brackets (B) onto the driver's (left) and passenger's (right) side axle. Position both lower brackets so they are up against the leaf spring and jounce bumper strike plate/axle spacer assembly. While setting the U-bolts (G) into position forward and rearward of the axle, make sure inside legs of both U-bolts go through the holes in the lower bracket (Fig. 25). Install a zip tie (JJ) around the ABS/brake line just below the lower bracket.

NOTE

It may be necessary to trim the ABS/brake line bracket previously modified if the lower bracket does not fit into position without interference.

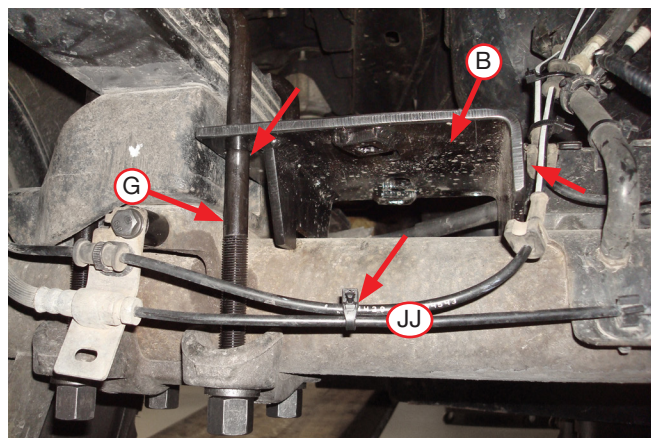

Driver's (left) side lower bracket and hardware shown.

Fig. 25

23. Insert the 3/8" carriage bolts (Y) down through the holes in the upper bracket making sure the rear carriage bolts go between the hard brake lines and the axle (Fig. 26 & Fig. 27). Turn the heads of the carriage bolts so they index into the square holes in the bracket.



Fig. 26

24. Raise the axle assembly or lower the body all the way so that the leaf spring is supporting the vehicle. Set the lower axle/spring retainer over the U-bolts and cap with 9/16" flat washers (HH) and 9/16" deep nuts (AA). Equally tighten finger-tight only.

NOTE

Ensure the lower axle/spring retainer aligns with the wear marks on the axle before torquing U-bolts.

25. Install the lower clamp bar (A) over the carriage bolts previously installed and cap with 3/8" serrated flange lock nuts (BB). Tighten finger-tight only (Fig. 27).

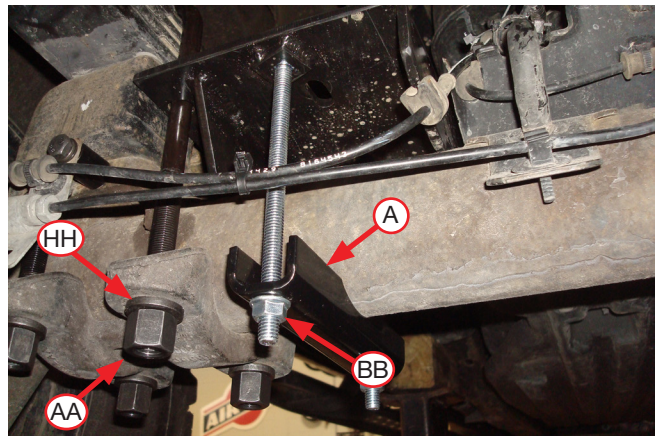

Fig. 27

26. In a crisscross pattern, evenly torque the U-bolts to 90 lb.-ft. (122Nm) of torque. Once all the U-bolts have been torqued, torque the 3/8" lower bracket axle clamp hardware to 16 lb.-ft (22Nm).

NOTE

U-bolts must be re-torqued after 100 miles.

27. Install an oval P clamp (P) onto the emergency brake cable that is forward of the lower bracket on the driver's (left) side (Fig. 28). Insert a 3/8" carriage bolt (V) into the square hole that is in the corner of the lower bracket as shown.

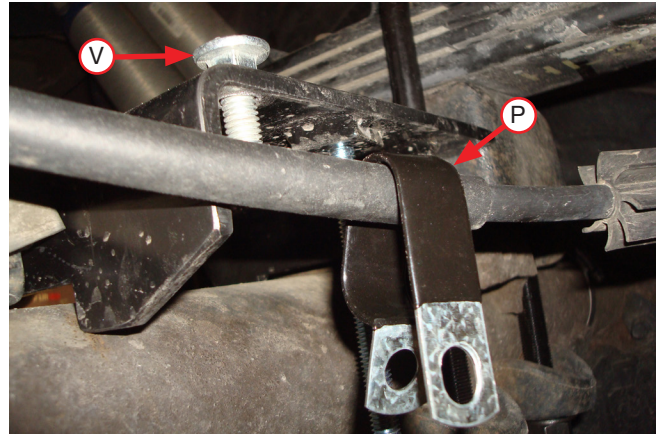

Fig. 28

28. Push down and rotate the carriage bolt into position on the bracket. Rotate and install the oval P clamp over the threaded end of the carriage bolt. Attach with 3/8" nylon lock nut (CC) and flat washer (DD) (Fig. 29). Tighten securely.

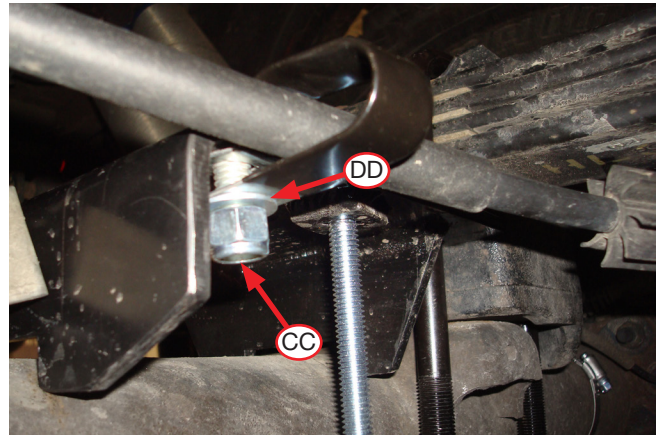

Fig. 29

ASSEMBLING THE AIR SPRINGS

1. Set a roll plate (I) onto the top of the air springs (J) and install the fittings (K) into the top of the air spring finger-tight. Tighten the fitting an additional 1 1/2 turns (Fig. 30).

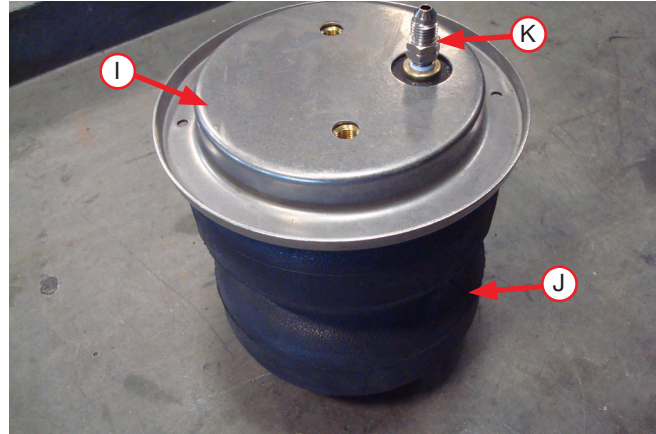

Fig. 30

2. Insert a 3/8" carriage bolt (V) into the square hole of the right-hand upper spring bracket (E) on the opposite side of the tapered holes as shown in Fig. 31. Set the bracket onto the air spring assembly and install with two flat-head screws (L). Torque the screws to no more than 20 lb.-ft. (27Nm). Install the braided hose (H) onto the fitting previously installed and turn one flat (see hose installation instructions at the end for reference).

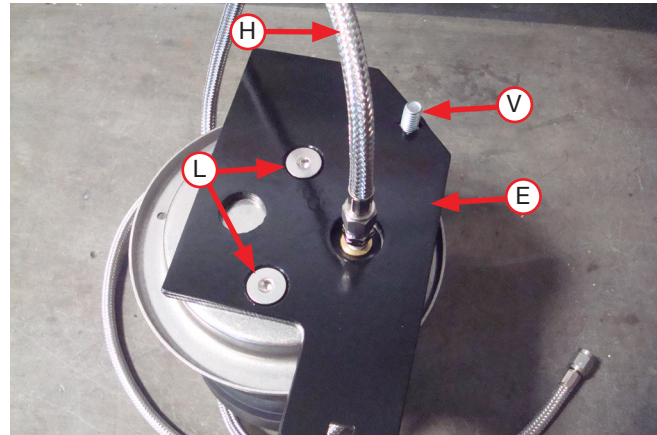

Fig. 31

3. Set the left-hand upper spring bracket (F) onto the remaining air spring and attach with two flat-head screws (L), install the hose on the fitting, as done on the right-hand air spring assembly. Fig. 32 shows a picture of both left- and right-hand assemblies ready to be installed.



Fig. 32

INSTALLING THE ASSEMBLIES

1. Lower the axle assembly or raise the frame once again, just far enough so that the air spring assemblies can be put in place between the upper and lower bracket. While positioning the driver's (left) assembly into position above the axle, insert the hose between wiring harness as shown in Fig. 33. Route the hose over the frame and to the back or side of the vehicle (see *Installing the Air Lines* instructions at the end for reference). Do the same for the passenger's (right) side assembly.

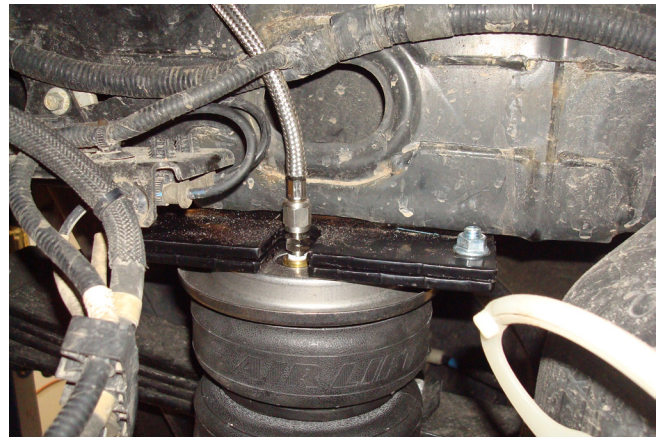

Driver's (Left) side shown.

Fig. 33

2. While lifting on the assemblies, insert two 3/8" carriage bolts (V) up through the air spring bracket and frame bracket (Fig. 33 & Fig. 34).

NOTE

The passenger's (right) side already has one of the 3/8" carriage bolts installed.

3. Cap with the 3/8" serrated flange lock nuts (BB). Torque hardware on both sides to 31 lb.-ft. (42Nm).
4. Set a roll plate (I) onto the lower bracket below the air spring assembly (Fig. 35). Align the holes in the air spring/roll plate/lower bracket as much as possible. Raise the axle assembly up or lower the frame just far enough so that the air spring sits on the lower bracket (Fig. 36).

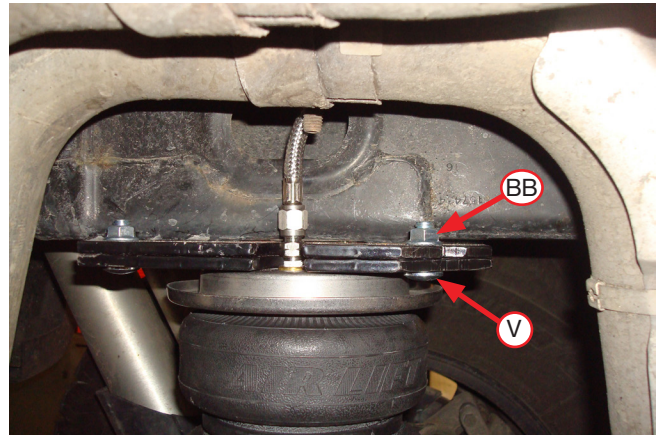

Passenger's (Right) side shown.

Fig. 34

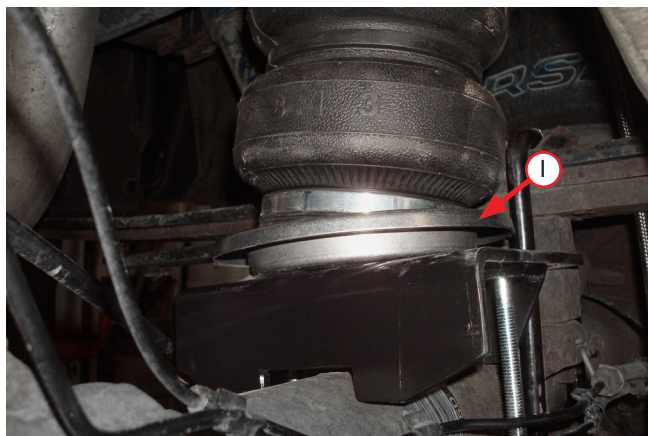

Fig. 35



Fig. 36

5. Install a 3/8" hex cap screw (M), split lock washer (N), and flat washer (O) in the air spring through the lower bracket (Fig. 37). Push the air spring so that the hardware is to the back of the slot and tighten the hardware securely.

TECH TIP

A 9/16" ratchet wrench works well in tightening this hardware.

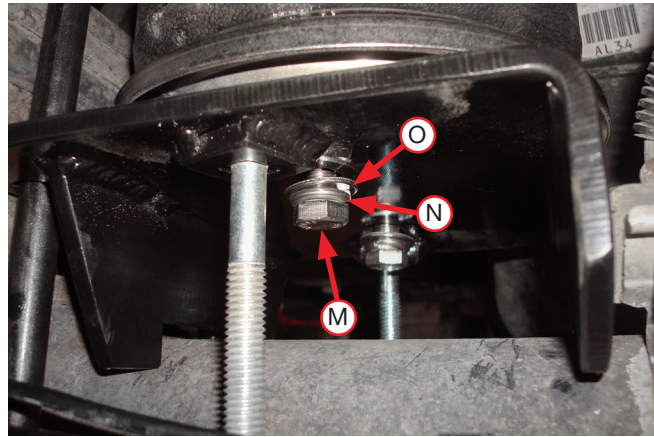

Fig. 37

6. Raise the axle assembly or lower the frame of the vehicle. Remove the safety stands and wheel chocks. On the inside frame of the driver's (left) side above the air spring assembly, ensure the wiring harness is not rubbing on the steel braided air line (Fig. 33). Check all brake lines and wiring harnesses to ensure they are not rubbing on any components due to modifications made. For hard brake lines, adjust by bending the line to obtain clearance (Fig. 38).

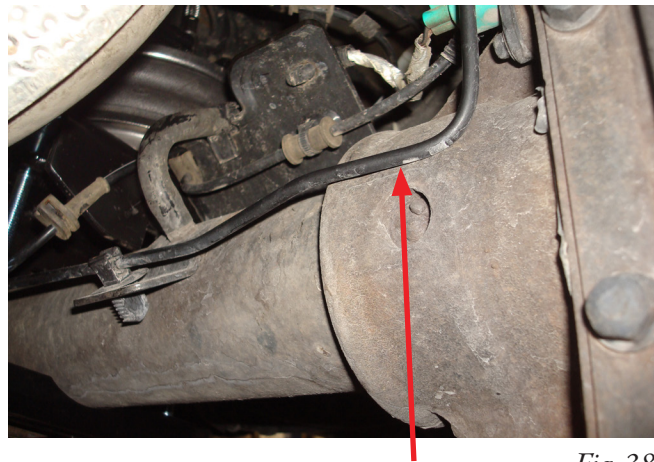

Fig. 38

Look for rubbing from modification made to brake components. Adjust where necessary.

Installing the Air Lines

INSTALLING BRAIDED STAINLESS STEEL AIR LINES

CAUTION

KEEP THE AIR LINE AWAY FROM THE FUEL LINE, BRAKE LINES AND ELECTRICAL WIRES.

NOTE

The braided stainless steel air line must be routed to the rear of the vehicle. Install the air line through one of the openings between the upper coil spring mount and the frame and then back to the rear where the inflation valves will be mounted (Fig. 39).

1. Use zip ties to secure the air line to fixed points along the chassis every 6" to 8" (150-200mm). Leave at least 2" (50mm) of slack to allow for any movement that might pull on the air line.
2. Tighten the air line hex nut finger-tight, then use 2 wrenches to turn 1 additional flat (1/6 of one full turn). Do not overtighten (Fig. 40 & Fig. 41). The easiest way to tighten the fitting is off the vehicle. Install the Schrader valve in the chosen location.
3. Coil and secure any excess air line in an area where it will not be susceptible to damage. The braided stainless steel air line cannot be trimmed.

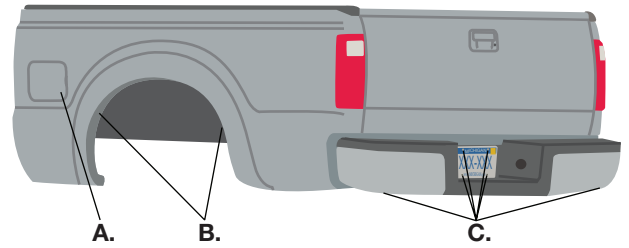

* For LoadLifter 5000 Ultimate Plus kits, the recommended location for the Schrader valves is the rear bumper area or license plate.

- A. Inside fuel tank filler door
- B. Inside rear wheel wells
- C. License plate or rear bumper area*

Fig. 39

Air Line Setup Without Compressor System

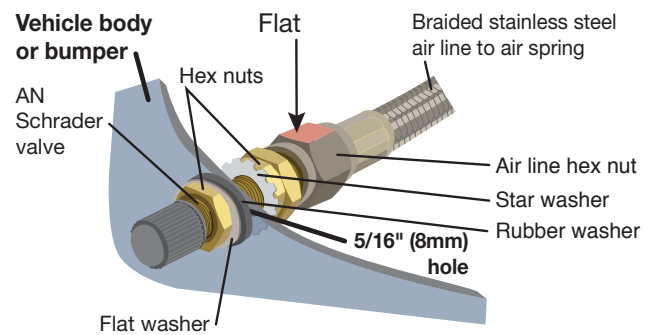

Fig. 40

Air Line Setup for Compressor Integration

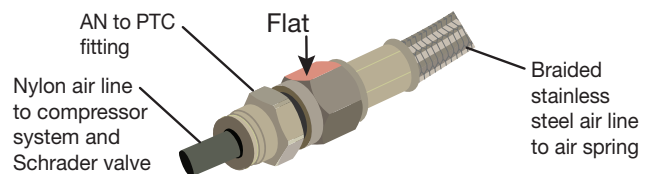

Fig. 41

Finished Installation

The images show the finished installation of both sides (Fig. 42 - Fig. 45).

NOTE

Misalignment of the lower and upper air spring brackets are normal for this installation.



Driver's (left) side behind the axle view.

Fig. 42



Driver's (left) side inside above the axle assembly view.

Fig. 43



Passenger's (right) forward axle view.

Fig. 44



Passenger's (right) inside rear axle view.

Fig. 45

INSTALLATION CHECKLIST

- Clearance test** — Inflate the air springs to 40-60 PSI (2.8-4.1BAR) and make sure there is at least 1/2" (13mm) clearance from anything that might rub against each sleeve. Be sure to check the tire, brakes, frame, shock absorbers and brake cables.
- Leak test before road test** — Inflate the air springs to 40-60 PSI (2.8-4.1BAR) and check all connections for leaks. All leaks must be eliminated before the vehicle is road tested.
- Heat test** — Be sure there is sufficient clearance from heat sources, at least 6" (152mm) for air springs and air lines. If a heat shield was included in the kit, install it. If there is no heat shield, but one is required, call Air Lift customer service at (800) 248-0892.
- U-bolt** - After 100 miles (161km), retorque U-bolts.
- Fastener test** — After 500 miles (800km), recheck all bolts for proper torque.
- Road test** — The vehicle should be road tested after the preceding tests. Inflate the air springs to recommended driving pressures. Drive the vehicle 10 miles (16km) and recheck for clearance, loose fasteners and air leaks.
- Operating instructions** — If professionally installed, the installer should review the operating instructions with the owner. Be sure to provide the owner with all of the paperwork that came with the kit.

MAINTENANCE AND USE GUIDELINES

1. Check air pressure weekly.
2. Always maintain normal ride height. Never inflate beyond 100 PSI (7BAR).
3. If the system develops an air leak, use a soapy water solution to check all air line connections and the inflation valve core before deflating and removing the air spring.

Minimum Recommended Pressure
5 PSI (.34BAR)

Maximum Air Pressure
100 PSI (7BAR)

CAUTION

FOR SAFETY AND TO PREVENT POSSIBLE DAMAGE TO THE VEHICLE, DO NOT EXCEED MAXIMUM GROSS VEHICLE WEIGHT RATING (GVWR) OR PAYLOAD RATING, AS INDICATED BY THE VEHICLE MANUFACTURER. ALTHOUGH THE AIR SPRINGS ARE RATED AT A MAXIMUM INFLATION PRESSURE OF 100 PSI (7BAR), THE AIR PRESSURE ACTUALLY NEEDED IS DEPENDENT ON LOAD AND GROSS VEHICLE WEIGHT RATING.